

# Toolholders

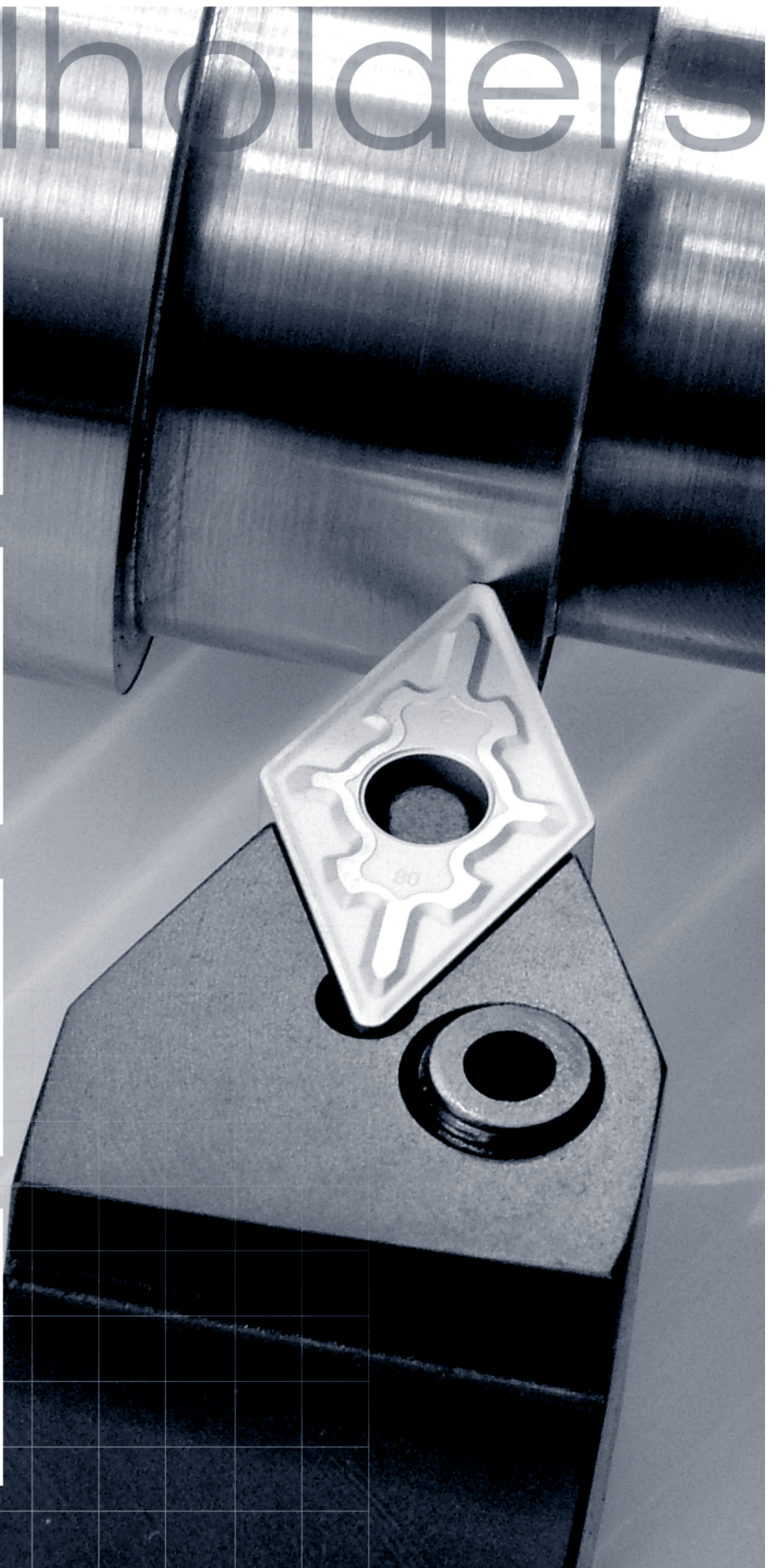
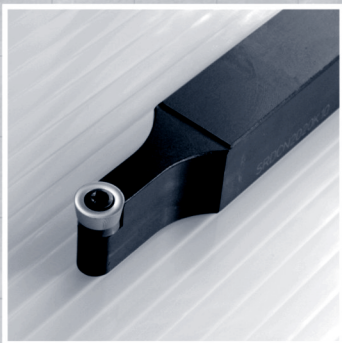
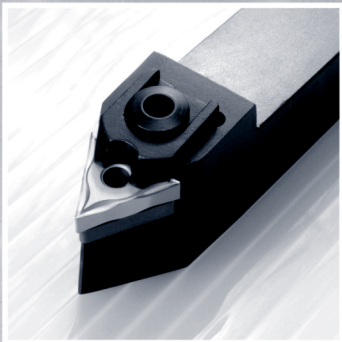
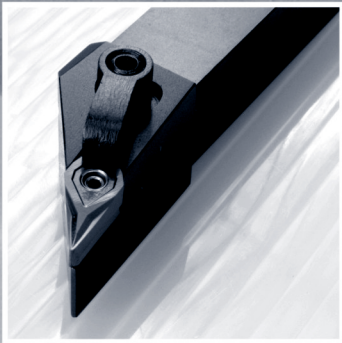

# Toolholders

Technical information	B.02
Applications index	B.04
Top clamp toolholders	B.06
Dimple lock	B.21
Wedge clamp toolholders	
Double lock toolholders	B.26
Lever lock toolholders	B.40
Center screw toolholders	B.60
Cutting speed	B.82
Special tools	B.84

General turning

Aluminium  
wheel turning

Automatic lathes

Ceramic tools

Parting and  
grooving

Threading

Drills

Cartridges

Brazed tools

Tooling

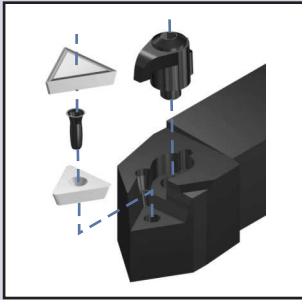

**(C) Top clamp**

The classic positive insert clamping system is designed to hold flat positive inserts, both with additional or sintered chipbreaker.

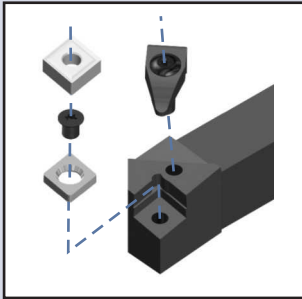
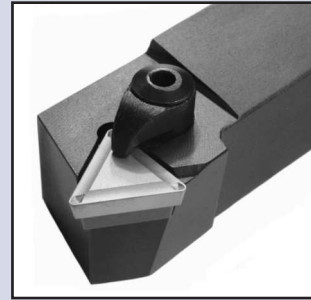

**(D) Dimple lock**

The "D" clamping system avoids insert movement during high feed or heavily interrupted machining, due to its accurate indexing that holds the insert securely clamped.

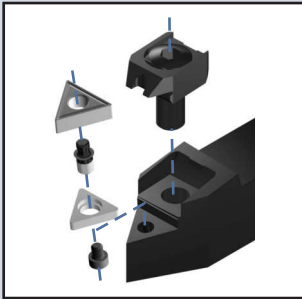
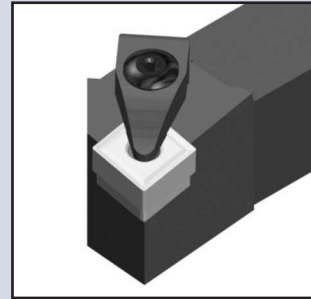

**(M) Wedge clamp**

Negative inserts require good clamping force for heavy duty work, for this purpose we have designed our "M" system, one of the strongest and safest available.

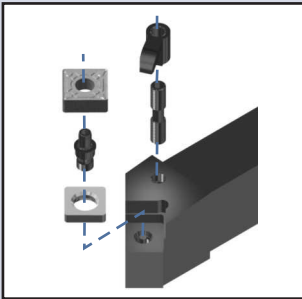
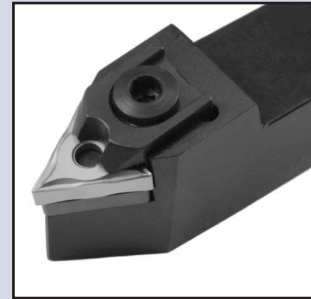

**(M-K) Double lock**

The double lock system offers good rigidity in negative inserts clamping, it is the first choice for center hole negative ceramic and cermet inserts.

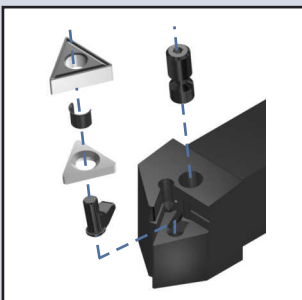
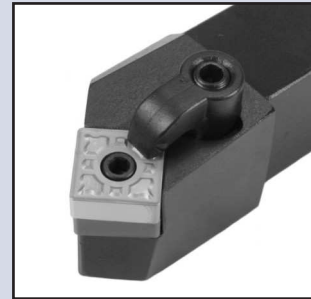

**(P) Lever lock**

The classic lever lock system allows a wide range of applications, it is the first choice for general purpose turning toolholders.

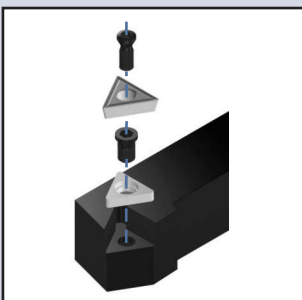
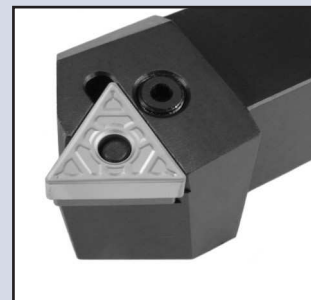

**(S) Center screw**

Since the advent of the TORX screw it has been possible to hold with complete safety positive inserts with center hole. Our range covers all the screw fixing permutations.

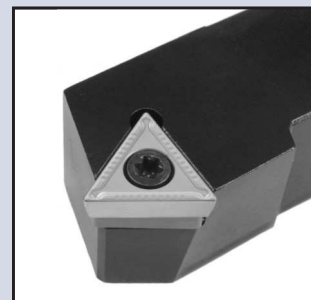

<b>P</b>	<b>C</b>	<b>L</b>	<b>N</b>	<b>R</b>	<b>25</b>	<b>25</b>	<b>M</b>	<b>12</b>
<b>1</b>	<b>2</b>	<b>3</b>	<b>4</b>	<b>5</b>	<b>6</b>	<b>7</b>	<b>8</b>	<b>9</b>

**1**

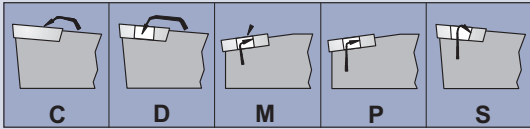

**2**

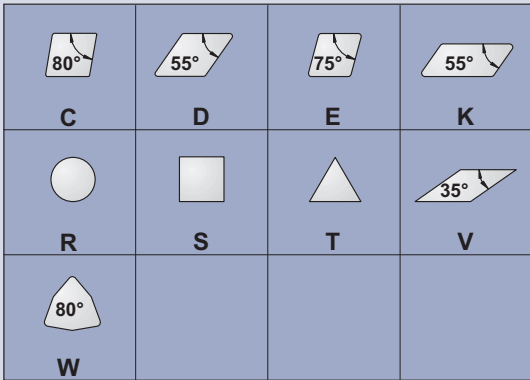

**4**

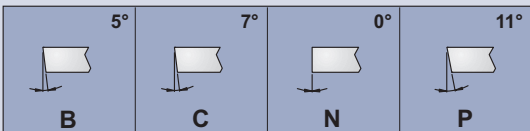

**5**

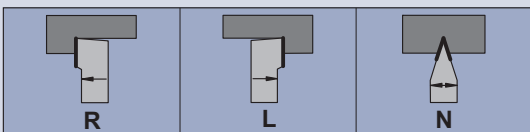

**8**

<p>Tool length, mm.</p>	<b>D</b>	60	<b>P</b>	170
	<b>E</b>	70	<b>R</b>	200
	<b>F</b>	80	<b>S</b>	250
	<b>H</b>	100	<b>T</b>	300
	<b>K</b>	125	<b>U</b>	350
	<b>L</b>	140	<b>V</b>	400
	<b>M</b>	150	<b>X</b>	Special

**3**

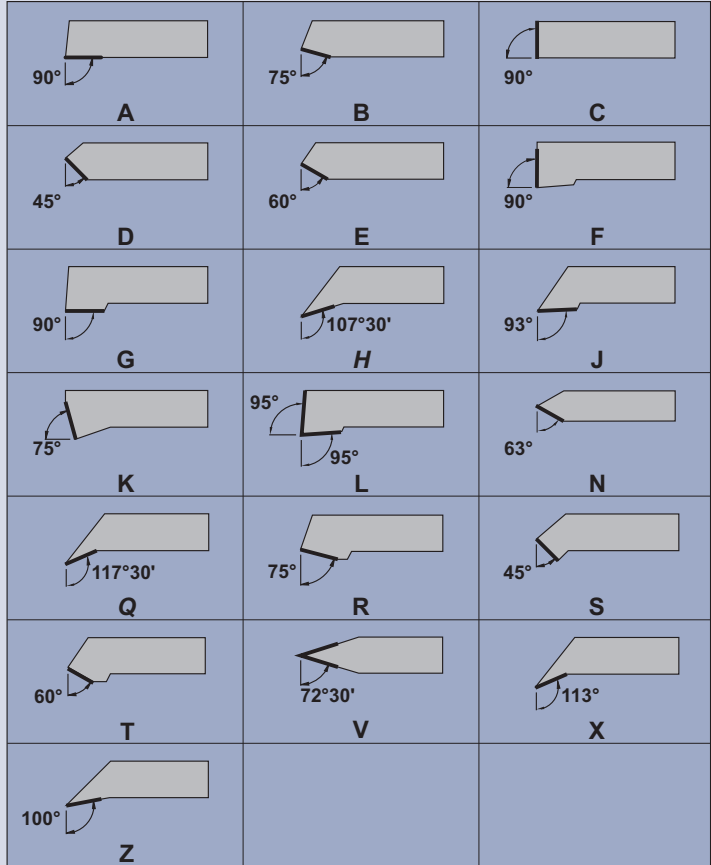

**6**

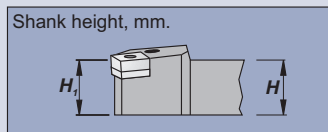

**7**

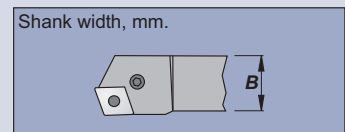

**9**

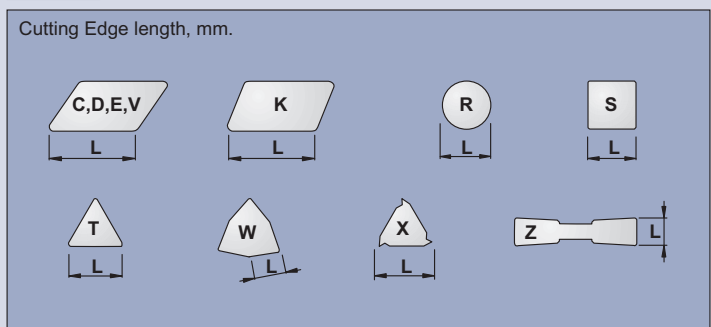

General turning  
Aluminium wheel turning  
Automatic lathes  
Ceramic tools  
Parting and grooving  
Threading  
Drills  
Cartridges  
Brazed tools  
Tooling



Inserts

General turning

Top clamp toolholders

<p><b>CKJN 93°</b></p> <p>Page B.06 KNUX 1604..</p>	<p><b>CKNN 63°</b></p> <p>Page B.07 KNUX 1604..</p>	<p><b>CSBP 75°</b></p> <p>Page B.08 SP.. 0903.. SP.. 1203.. SP.. 1904..</p>	<p><b>CSDP 45°</b></p> <p>Page B.09 SP.. 0903.. SP.. 1203..</p>	<p><b>CSKP 75°</b></p> <p>Page B.10 SP.. 0903.. SP.. 1203.. SP.. 1904..</p>	<p><b>CSSP 45°</b></p> <p>Page B.11 SP.. 0903.. SP.. 1203.. SP.. 1904..</p>
<p><b>CSTP 60°</b></p> <p>Page B.12 SP.. 0903.. SP.. 1203..</p>	<p><b>CTBP 75°</b></p> <p>Page B.13 TP.. 1103.. TP.. 1603..</p>	<p><b>CTCPN 90°</b></p> <p>Page B.14 TP.. 1103.. TP.. 1603.. TP.. 2204..</p>	<p><b>CTCP 90°</b></p> <p>Page B.15 TP.. 1103.. TP.. 1603.. TP.. 2204..</p>	<p><b>CTDP 45°</b></p> <p>Page B.16 TP.. 1103.. TP.. 1603.. TP.. 2204..</p>	<p><b>CTFP 90°</b></p> <p>Page B.17 TP.. 1103.. TP.. 1603.. TP.. 2204..</p>
<p><b>CTGP 90°</b></p> <p>Page B.18 TP.. 1103.. TP.. 1603.. TP.. 2204..</p>	<p><b>CTTP 60°</b></p> <p>Page B.19 TP.. 0902.. TP.. 1103.. TP.. 1603..</p>				



Dimple lock toolholders

<p><b>DCLN 95°</b></p> <p>Page B.21 CN.. 1204.. CN.. 1906..</p>	<p><b>DDJN 93°</b></p> <p>Page B.22 DN.. 1506..</p>	<p><b>DSSN 45°</b></p> <p>Page B.23 SNM.. 1204.. SNM.. 1906..</p>	<p><b>DTGN 90°</b></p> <p>Page B.24 TNM.. 1604.. TNM.. 2204..</p>	<p><b>DWLN 95°</b></p> <p>Page B.25 WNMG 0804..</p>	
---	---	---	---	---	--

Wedge clamp / Double lock toolholders

<p><b>MCLN 95°</b></p> <p>Page B.26 CN.. 1204.. CN.. 1906..</p>	<p><b>MCLN-K 95°</b></p> <p>Page B.27 CN.. 1204.. CN.. 1906..</p>	<p><b>MDJN-K 93°</b></p> <p>Page B.28 DN.. 1506..</p>	<p><b>MSSN-K 45°</b></p> <p>Page B.29 SNM.. 1204..</p>	<p><b>MSSN 45°</b></p> <p>Page B.30 SNM.. 1204.. SNM.. 1906..</p>	<p><b>MTEN 60°</b></p> <p>Page B.31 TNM.. 1604.. TNM.. 2204..</p>
<p><b>MTJN 93°</b></p> <p>Page B.32 TNM.. 1604.. TNM.. 2204..</p>	<p><b>MTJN-K 93°</b></p> <p>Page B.33 TNM.. 1604.. TNM.. 2204..</p>	<p><b>MTNN 63°</b></p> <p>Page B.34 TNM.. 1604.. TNM.. 2204..</p>	<p><b>MVJN-K 93°</b></p> <p>Page B.35 VN.. 1604..</p>	<p><b>MVQN-K 117° 30'</b></p> <p>Page B.36 VN.. 1604..</p>	<p><b>MVVN-K 72° 30'</b></p> <p>Page B.37 VN.. 1604..</p>
<p><b>MWLN 95°</b></p> <p>Page B.38 WNMG 0604.. WNMG 0804..</p>	<p><b>MWLN-K 95°</b></p> <p>Page B.39 WNM.. 0804..</p>				

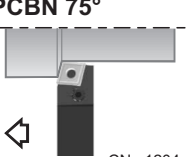
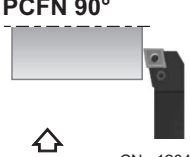
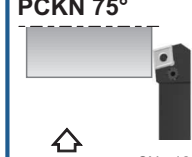
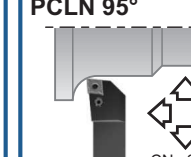
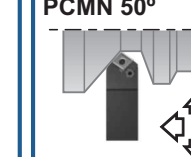
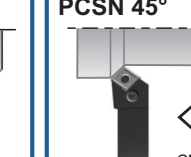
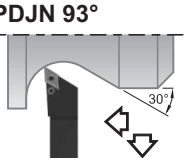
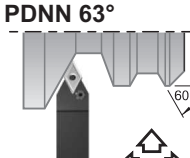
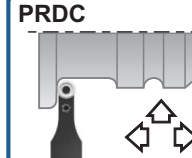
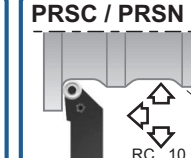
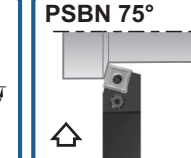
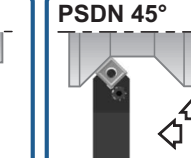
Lever lock toolholders

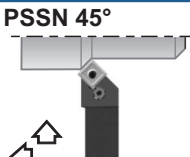
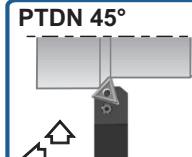
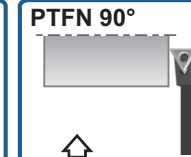
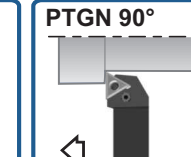
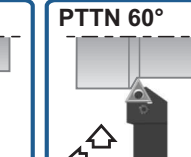
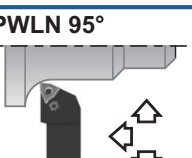
<p><b>PCBN 75°</b></p>  <p>Page B.40 CN.. 1204.. CN.. 1606.. CN.. 1906..</p>	<p><b>PCFN 90°</b></p>  <p>Page B.41 CN.. 1204.. CN.. 1606.. CN.. 1906..</p>	<p><b>PCKN 75°</b></p>  <p>Page B.42 CN.. 1204.. CN.. 1906.. CN.. 2509..</p>	<p><b>PCLN 95°</b></p>  <p>Page B.43 CN.. 0903.. ... CN.. 2509..</p>	<p><b>PCMN 50°</b></p>  <p>Page B.44 CN.. 1204.. CN.. 1906..</p>	<p><b>PCSN 45°</b></p>  <p>Page B.45 CN.. 1204.. CN.. 1606.. CN.. 1906..</p>
<p><b>PDJN 93°</b></p>  <p>Page B.46 DN.. 1104.. DN.. 1506..</p>	<p><b>PDNN 63°</b></p>  <p>Page B.47 DN.. 1506..</p>	<p><b>PRDC</b></p>  <p>Page B.48 RC.. 1003M0 ... RC.. 3209M0</p>	<p><b>PRSC / PRSN</b></p>  <p>Page B.49 / B.50 RC.. 10..32 RNMG 09..25</p>	<p><b>PSBN 75°</b></p>  <p>Page B.51 SNM.. 0903.. ... SNM.. 2507..</p>	<p><b>PSDN 45°</b></p>  <p>Page B.52 SNM.. 0903.. ... SNM 2507..</p>
<p><b>PSKN 75°</b></p>  <p>Page B.53 SNM.. 0903.. ... SNM.. 2507..</p>	<p><b>PSSN 45°</b></p>  <p>Page B.54 SNM.. 0903.. ... SNM.. 2507..</p>	<p><b>PTDN 45°</b></p>  <p>Page B.55 TNM.. 2204..</p>	<p><b>PTFN 90°</b></p>  <p>Page B.56 TNM.. 1604.. TNM.. 2204.. TNM.. 2706..</p>	<p><b>PTGN 90°</b></p>  <p>Page B.57 TNM.. 1604.. ... TNM.. 3307..</p>	<p><b>PTTN 60°</b></p>  <p>Page B.58 TNM.. 1604.. TNM.. 2204..</p>
<p><b>PWLN 95°</b></p>  <p>Page B.59 WNM.. 0604.. WNM.. 0804..</p>					

Center screw toolholders

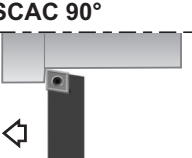
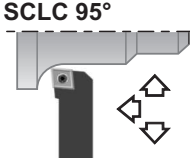
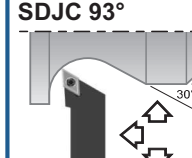
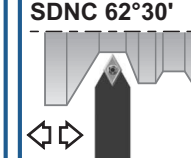
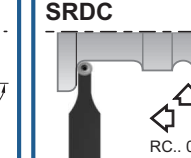
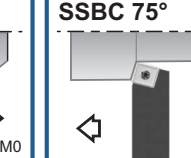
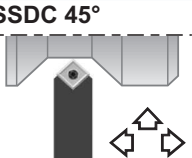
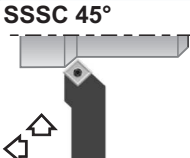
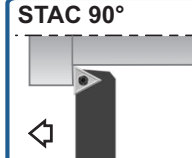
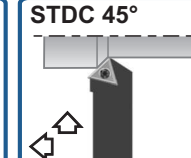
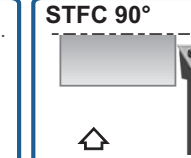
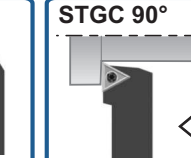
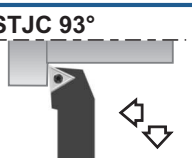
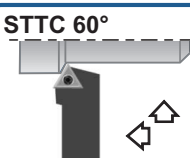
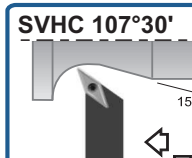
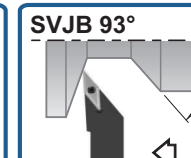
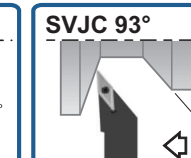
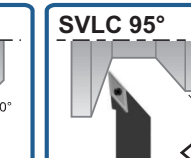
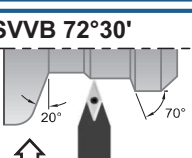
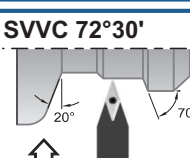
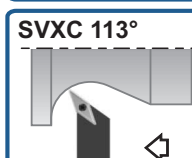
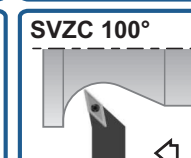
<p><b>SCAC 90°</b></p>  <p>Page B.60 CC.. 0602.. CC.. 09T3.. CC.. 1204..</p>	<p><b>SCLC 95°</b></p>  <p>Page B.61 CC.. 0602.. CC.. 09T3.. CC.. 1204..</p>	<p><b>SDJC 93°</b></p>  <p>Page B.62 DC.. 0702.. DC.. 11T3..</p>	<p><b>SDNC 62°30'</b></p>  <p>Page B.63 DC.. 0702.. DC.. 11T3..</p>	<p><b>SRDC</b></p>  <p>Page B.64 RC.. 0602M0 RC.. 0803M0 RC.. 10T3M0 RC.. 1204M0</p>	<p><b>SSBC 75°</b></p>  <p>Page B.65 SC.. 09T3.. SC.. 1204..</p>
<p><b>SSDC 45°</b></p>  <p>Page B.66 SC.. 09T3.. SC.. 1204..</p>	<p><b>SSSC 45°</b></p>  <p>Page B.67 SC.. 09T3.. SC.. 1204..</p>	<p><b>STAC 90°</b></p>  <p>Page B.68 TC.. 0902.. TC.. 1102.. TC.. 16T3..</p>	<p><b>STDC 45°</b></p>  <p>Page B.69 TC.. 0902.. TC.. 1102.. TC.. 16T3..</p>	<p><b>STFC 90°</b></p>  <p>Page B.70 TC.. 0902.. TC.. 1102.. TC.. 16T3..</p>	<p><b>STGC 90°</b></p>  <p>Page B.71 TC.. 0902.. TC.. 1102.. TC.. 16T3..</p>
<p><b>STJC 93°</b></p>  <p>Page B.72 TC.. 0902.. TC.. 1102.. TC.. 16T3..</p>	<p><b>STTC 60°</b></p>  <p>Page B.73 TC.. 0902.. TC.. 1102.. TC.. 16T3..</p>	<p><b>SVHC 107°30'</b></p>  <p>Page B.74 VC.. 1604..</p>	<p><b>SVJB 93°</b></p>  <p>Page B.75 VBMT 1604..</p>	<p><b>SVJC 93°</b></p>  <p>Page B.76 VC.. 1103.. VC.. 1604..</p>	<p><b>SVLC 95°</b></p>  <p>Page B.77 VCMT 1303..</p>
<p><b>SVVB 72°30'</b></p>  <p>Page B.78 VBMT 1604..</p>	<p><b>SVVC 72°30'</b></p>  <p>Page B.79 VC.. 1103.. VC.. 1604..</p>	<p><b>SVXC 113°</b></p>  <p>Page B.80 VCMT 1303..</p>	<p><b>SVZC 100°</b></p>  <p>Page B.81 VC.. 1604..</p>		

General turning

Aluminium wheel turning

Automatic lathes

Ceramic tools

Parting and grooving

Threading

Drills

Cartridges

Brazed tools

Tooling

Inserts

General turning

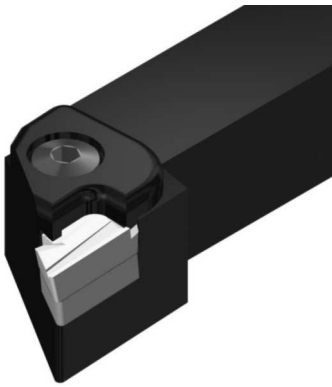

**Characteristics:**

Toolholder for turning and profiling operations equipped with KNUX super-positive insert that generates low cutting forces. The top clamp ensures good stability and good rigidity.

**Applications:**

Profiling toolholder for semi-finishing and finishing operations.

**Axial:** 0°  
**Radial:** -6°

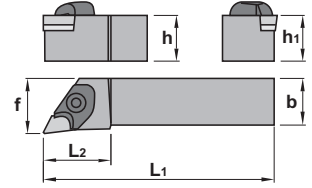
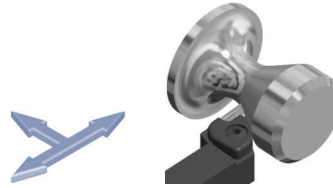

# CKJN 93°

Ref.		h=h <sub>1</sub>	b	L <sub>1</sub>	L <sub>2</sub>	f	Insert size	Kg
CKJN R/L 2020 K16		20	20	125	34	30	KNUX 1604..	0,390
CKJN R/L 2525 M16		25	25	150	34	32	KNUX 1604..	0,700
CKJN R/L 3225 P16		32	25	170	34	32	KNUX 1604..	1,000
CKJN R/L 3232 P16		32	32	170	34	40	KNUX 1604..	1,250
CKJN R/L 4025 R16		40	25	200	34	32	KNUX 1604..	1,500

Ref.							
CKJN R 2020 K16	2316	1614	5004	4295	4203	3226	4012
CKJN R 2525 M16	2316	1614	5004	4295	4204	3226	4012
CKJN R 3225 P16	2316	1614	5004	4295	4204	3226	4012
CKJN R 3232 P16	2316	1614	5004	4295	4204	3226	4012
CKJN R 4025 R16	2316	1614	5004	4295	4204	3226	4012
CKJN L 2020 K16	2326	1614	5004	4295	4203	3236	4012
CKJN L 2525 M16	2326	1614	5004	4295	4204	3236	4012
CKJN L 3225 P16	2326	1614	5004	4295	4204	3236	4012
CKJN L 3232 P16	2326	1614	5004	4295	4204	3236	4012
CKJN L 4025 R16	2326	1614	5004	4295	4204	3236	4012

KNUX		l	s	d	Negative KNUX insert.
Ref.	KNUX 1604..	16,00	4,76	9,52	
For more information see page: A.25					
KNUX					

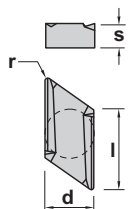

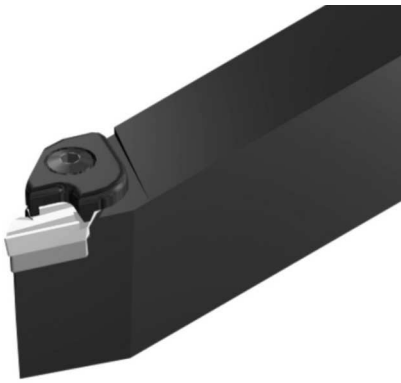

**Characteristics:**

Toolholder for turning and profiling operations equipped with KNUX super-positive insert that generates low cutting forces. The top clamp ensures good stability and good rigidity.

**Applications:**

Profiling toolholder for semi-finishing and finishing operations.

**Axial:** -2.75°  
**Radial:** -5.25°

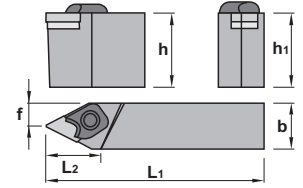
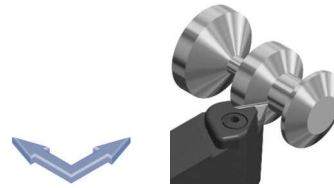

# CKNN 63°

Ref.		h=h1	b	L1	L2	f	Insert size	kg
Ref.	CKNN R/L 4025 R16	40	25	200	37	14,3	KNUX 1604..	1,500
	CKNN R/L 5032 S16	50	32	250	37	16,8	KNUX 1604..	3,000

Ref.								
Ref.	CKNN R 4025 R16	2316	1614	5004	4295	4204	3226	4012
	CKNN R 5032 S16	2316	1614	5004	4295	4204	3226	4012
Ref.	CKNN L 4025 R16	2326	1614	5004	4295	4204	3236	4012
	CKNN L 5032 S16	2326	1614	5004	4295	4204	3236	4012

Ref.	KNUX			Negative KNUX insert.
	l	s	d	
Ref.	KNUX 1604..	16,00	4,76	9,52
For more information see page: A.25				
	KNUX			

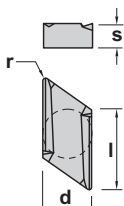



Inserts

General turning



**Characteristics:**

Toolholder for external turning applications equipped with square positive inserts and strong cutting edges. The top clamp ensures good rigidity and stability.

**Applications:**

External turning toolholder for all kind of materials. The workpiece should be stable.





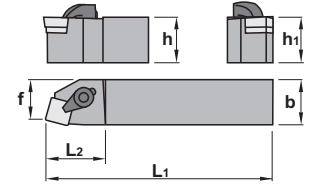
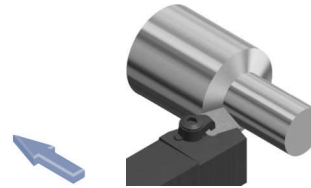

For interrupted cut choose toolholder Ref. PSBN (Page: B.51).

**Axial:** 1.50°  
**Radial:** 5.75°



# CSBP 75°



Ref.		h=h <sub>1</sub>	b	L <sub>1</sub>	L <sub>2</sub>	f	Insert size	kg
CSBP R/L 1212 F09	CSBP R/L 1212 F09	12	12	80	22	11	SP..0903..	0,070
	CSBP R/L 1616 H09	16	16	100	22	13	SP..0903..	0,200
	CSBP R/L 2020 K09	20	20	125	22	17	SP..0903..	0,400
CSBP R/L 2020 K12	CSBP R/L 2020 K12	20	20	125	34	17	SP..1203..	0,400
	CSBP R/L 2525 M12	25	25	150	34	22	SP..1203..	0,700
	CSBP R/L 3225 P12	32	25	170	34	22	SP..1203..	1,000
CSBP R/L 3232 P19	CSBP R/L 3232 P19	32	32	170	40	27	SP..1904..	1,250
	CSBP R/L 4040 S19	40	40	250	40	35	SP..1904..	3,000
	CSBP R/L 5050 T19	50	50	300	40	43	SP..1904..	5,650

Ref.							
CSBP R/L 1212 F09	CSBP R/L 1212 F09	2207	5025	3109	4002	2407	9009
	CSBP R/L 1616 H09	2207	5025	3109	4002	2407	9009
	CSBP R/L 2020 K09	2207	5025	3109	4002	2407	9009
CSBP R/L 2020 K12	CSBP R/L 2020 K12	2209	5003	3112	4002	2409	9012 - 9112
	CSBP R/L 2525 M12	2209	5003	3112	4002	2409	9012 - 9112
	CSBP R/L 3225 P12	2209	5003	3112	4002	2409	9012 - 9112
CSBP R/L 3232 P19	CSBP R/L 3232 P19	2211	5004	3119	4012	2411	9019 - 9119
	CSBP R/L 4040 S19	2211	5004	3119	4012	2411	9019 - 9119
	CSBP R/L 5050 T19	2211	5004	3119	4012	2411	9019 - 9119

Supplementary accessories

Ref.	SP..	l	s	d	Positive 11° clearance - Square inserts.
	SP.. 0903..	9,52	3,18	9,52	
SP.. 1203..	12,70	3,18	12,70		
SP.. 1904..	19,05	4,76	19,05		

SPMR-33	SPUN				
					

For more information see page: A.28

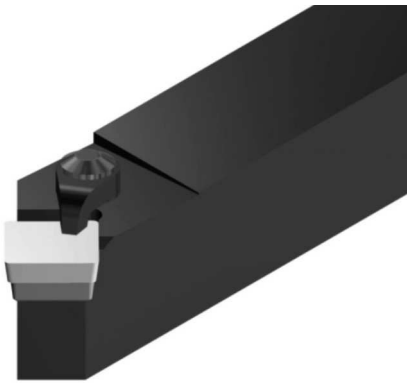

**Characteristics:**

Toolholder for external turning and chamfering applications equipped with square positive inserts and strong cutting edges. The top clamp ensures good rigidity and stability.

**Applications:**

External turning and chamfering toolholder for all kind of materials. The workpiece should be stable.

For interrupted cut choose toolholder Ref. PSDNN (Page: B.52).

**Axial:** 4.25°  
**Radial:** 4.25°

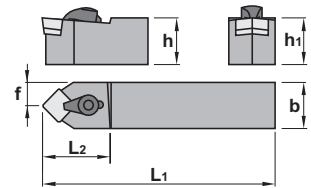
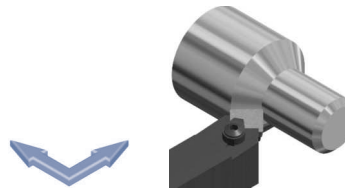

## CSDP 45°

Ref.		h=h <sub>1</sub>	b	L <sub>1</sub>	L <sub>2</sub>	f	Insert size	kg
CSDP R/L	1010 E09	10	10	70	22	5,6	SP.. 0903..	0,030
	1212 F09	12	12	80	22	7,6	SP.. 0903..	0,070
	1616 H09	16	16	100	22	11,6	SP.. 0903..	0,200
CSDP R/L	2020 K12	20	20	125	28	14,0	SP.. 1203..	0,400
	2525 M12	25	25	150	28	19,0	SP.. 1203..	0,700
CSDP N	1010 E09	10	10	70	22	5,0	SP.. 0903..	0,030
	1212 F09	12	12	80	22	6,0	SP.. 0903..	0,070
	1616 H09	16	16	100	22	8,0	SP.. 0903..	0,200
CSDP N	2020 K12	20	20	125	28	10,0	SP.. 1203..	0,400
	2525 M12	25	25	150	28	12,5	SP.. 1203..	0,700

Ref.							
CSDP R/L	1010 E09	2107	5025	-	-	-	9509-9609
	1212 F09	2207	5025	3109	4002	2407	9509-9609
	1616 H09	2207	5025	3109	4002	2407	9509-9609
CSDP R/L	2020 K12	2209	5003	3112	4002	2409	9512-9612
	2525 M12	2209	5003	3112	4002	2409	9512-9612
CSDP N	1010 E09	2107	5025	-	-	-	9509-9609
	1212 F09	2207	5025	3109	4002	2407	9509-9609
	1616 H09	2207	5025	3109	4002	2407	9509-9609
CSDP N	2020 K12	2209	5003	3112	4002	2409	9512-9612
	2525 M12	2209	5003	3112	4002	2409	9512-9612

Supplementary accessories

Ref.	SP..	l	s	d	Positive 11° clearance - Square inserts.
	SP.. 0903..	9,52	3,18	9,52	
SP.. 1203..	12,70	3,18	12,70		

For more information see page: A.28

SPMR-33	SPUN				

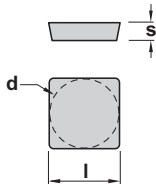

Inserts

General turning

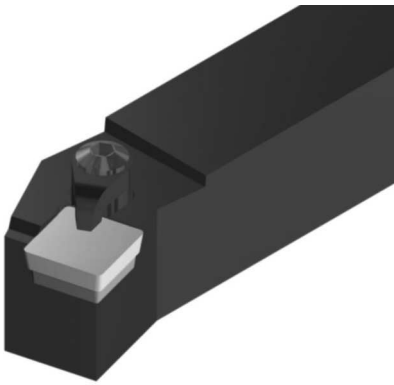

**Characteristics:**

Toolholder for face turning applications equipped with square positive inserts and strong cutting edges. The top clamp ensures good rigidity and stability.

**Applications:**

Face turning toolholder for all kind of materials. The workpiece should be stable.





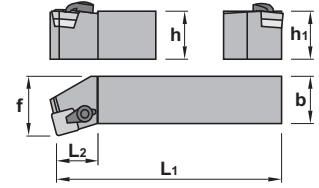
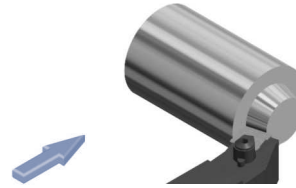

For interrupted cut choose toolholder Ref. PSKN (Page: B.53).

**Axial:** 5.75°  
**Radial:** 1.5°





# CSKP 75°

Ref.		h=h <sub>1</sub>	b	L <sub>1</sub>	L <sub>2</sub>	f	Insert size	kg
CSKP R/L 1212 F09	CSKP R/L 1212 F09	12	12	80	18	16	SP..0903..	0,070
	CSKP R/L 1616 H09	16	16	100	22	20	SP..0903..	0,200
	CSKP R/L 2020 K09	20	20	125	22	25	SP..0903..	0,400
CSKP R/L 2020 K12	CSKP R/L 2020 K12	20	20	125	28	25	SP..1203..	0,400
	CSKP R/L 2525 M12	25	25	150	28	32	SP..1203..	0,700
	CSKP R/L 3225 P12	32	25	170	28	32	SP..1203..	1,000
CSKP R/L 3232 P19	CSKP R/L 3232 P19	32	32	170	42	40	SP..1904..	1,250
	CSKP R/L 4040 S19	40	40	250	42	50	SP..1904..	3,000
	CSKP R/L 5050 T19	50	50	300	42	60	SP..1904..	5,650

Ref.							
CSKP R/L 1212 F09	CSKP R/L 1212 F09	2207	5025	3109	4002	2407	9009
	CSKP R/L 1616 H09	2207	5025	3109	4002	2407	9009
	CSKP R/L 2020 K09	2207	5025	3109	4002	2407	9009
CSKP R/L 2020 K12	CSKP R/L 2020 K12	2209	5003	3112	4002	2409	9012 - 9112
	CSKP R/L 2525 M12	2209	5003	3112	4002	2409	9012 - 9112
	CSKP R/L 3225 P12	2209	5003	3112	4002	2409	9012 - 9112
CSKP R/L 3232 P19	CSKP R/L 3232 P19	2211	5004	3119	4012	2411	9019 - 9119
	CSKP R/L 4040 S19	2211	5004	3119	4012	2411	9019 - 9119
	CSKP R/L 5050 T19	2211	5004	3119	4012	2411	9019 - 9119

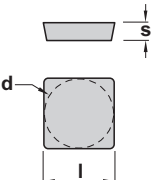
*Supplementary accessories*

SP..		l	s	d	Positive 11° clearance - Square inserts.  For more information see page: A.28
Ref.	SP.. 0903..	9,52	3,18	9,52	
	SP.. 1203..	12,70	3,18	12,70	
	SP.. 1904..	19,05	4,76	19,05	
	SPMR-33	SPUN			
					

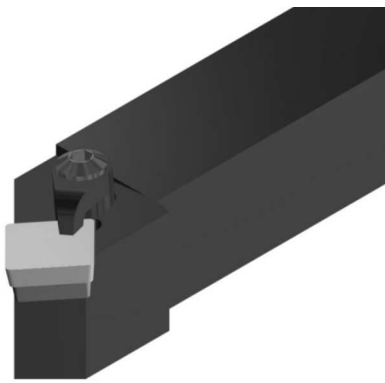

**Characteristics:**

Toolholder for external turning and chamfering applications equipped with square positive inserts and strong cutting edges. The top clamp ensures good rigidity and stability.

**Applications:**

External turning and chamfering toolholder for all kind of materials. The workpiece should be stable.

For interrupted cut choose toolholder Ref. PSSN (Page: B.54).

**Axial:** 4.25°  
**Radial:** 4.25°

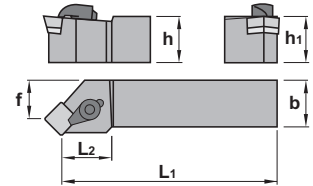
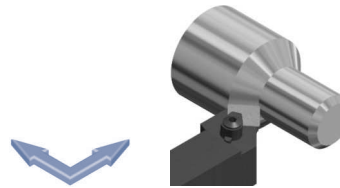

## CSSP 45°

Ref.		h=h <sub>1</sub>	b	L <sub>1</sub>	L <sub>2</sub>	f	Insert size	kg
CSSP R/L 1212 F09	CSSP R/L 1212 F09	12	12	80	22	16	SP.. 0903..	0,070
	CSSP R/L 1616 H09	16	16	100	22	20	SP.. 0903..	0,200
CSSP R/L 2020 K12	CSSP R/L 2020 K12	20	20	125	22	25	SP.. 1203..	0,400
	CSSP R/L 2525 M12	25	25	150	28	32	SP.. 1203..	0,700
	CSSP R/L 3225 P12	32	25	170	28	32	SP.. 1203..	1,000
CSSP R/L 3232 P19	CSSP R/L 3232 P19	32	32	170	42	40	SP.. 1904..	1,250
	CSSP R/L 4040 S19	40	40	250	42	50	SP.. 1904..	3,000

Ref.							
CSSP R/L 1212 F09	CSSP R/L 1212 F09	2207	5025	3109	4002	2407	9509-9609
	CSSP R/L 1616 H09	2207	5025	3109	4002	2407	9509-9609
CSSP R/L 2020 K12	CSSP R/L 2020 K12	2209	5003	3112	4002	2409	9512-9612
	CSSP R/L 2525 M12	2209	5003	3112	4002	2409	9512-9612
	CSSP R/L 3225 P12	2209	5003	3112	4002	2409	9512-9612
CSSP R/L 3232 P19	CSSP R/L 3232 P19	2211	5004	3119	4012	2411	9519-9619
	CSSP R/L 4040 S19	2211	5004	3119	4012	2411	9519-9619

*Supplementary accessories*

	SP..				Positive 11° clearance - Square inserts.
	Ref.	l	s	d	
	SP.. 0903..	9,52	3,18	9,52	
SP.. 1203..	12,70	3,18	12,70		
SP.. 1904..	19,05	4,76	19,05		
SPMR-33	SPUN				

For more information see page: A.28



Inserts

General turning



**Characteristics:**

Toolholder for external turning applications equipped with square positive inserts and strong cutting edges. The top clamp ensures good rigidity and stability.

**Applications:**





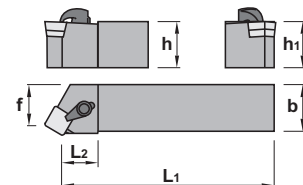
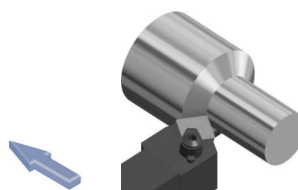

External turning toolholder for all kind of materials. The workpiece should be stable.

For interrupted cut choose toolholder Ref. PSBN (Page: B.51).

**Axial:** 3°  
**Radial:** 5.25°



<b>CSTP 60°</b>		<b>h=h<sub>1</sub></b>	<b>b</b>	<b>L<sub>1</sub></b>	<b>L<sub>2</sub></b>	<b>f</b>	<b>Insert size</b>	<b>kg</b>
Ref.	<b>CSTP R/L 1616 H09</b>	16	16	100	22	13	SP..0903..	0,200
	<b>CSTP R/L 2020 K09</b>	20	20	125	22	17	SP..0903..	0,350
	<b>CSTP R/L 2020 K12</b>	20	20	125	28	17	SP..1203..	0,400
	<b>CSTP R/L 2525 M12</b>	25	25	150	28	22	SP..1203..	0,700



Ref.						
<b>CSTP R/L 1616 H09</b>	2207	5025	3109	4002	2407	9009
<b>CSTP R/L 2020 K09</b>	2207	5025	3109	4002	2407	9009
<b>CSTP R/L 2020 K12</b>	2209	5003	3112	4002	2409	9012 - 9112
<b>CSTP R/L 2525 M12</b>	2209	5003	3112	4002	2409	9012 - 9112

*Supplementary accessories*

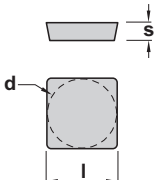
Ref.	<b>SP..</b>	<b>l</b>	<b>s</b>	<b>d</b>	Positive 11° clearance - Square inserts.
		<b>SP.. 0903..</b>	9,52	3,18	
	<b>SP.. 1203..</b>	12,70	3,18	12,70	



For more information see page: A.28

SPMR-33	SPUN				
					



**Characteristics:**

Toolholder for external turning applications equipped with triangular positive inserts and strong cutting edges. The top clamp ensures good rigidity and stability.

**Applications:**

External turning toolholder for all kind of materials. The workpiece should be stable.

**Axial:** 1.5°  
**Radial:** 5.75°

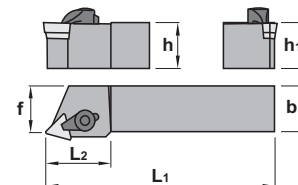
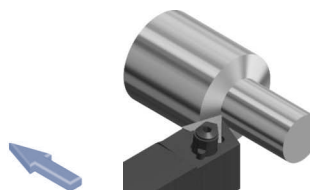

# CTBP 75°

Ref.		h=h1	b	L1	L2	f	Insert size	kg
CTBP R/L 1212 F11	CTBP R/L 1212 F11	12	12	80	18	11	TP.. 1103..	0,070
	CTBP R/L 1616 H11	16	16	100	22	13	TP.. 1103..	0,200
CTBP R/L 2020 K16	CTBP R/L 2020 K16	20	20	125	28	17	TP.. 1603..	0,400
	CTBP R/L 2525 M16	25	25	150	28	22	TP.. 1603..	0,700

Ref.							
CTBP R/L 1212 F11	CTBP R/L 1212 F11	2207	5025	-	-	2407	9011
	CTBP R/L 1616 H11	2207	5025	-	-	2407	9011
CTBP R/L 2020 K16	CTBP R/L 2020 K16	2209	5003	3116	4002	2409	9016-9116
	CTBP R/L 2525 M16	2209	5003	3116	4002	2409	9016-9116

Supplementary accessories

	TP..				Positive 11° clearance - Triangular inserts.
	Ref.	l	s	d	
	TP.. 1103..	11,00	3,18	6,35	
	TP.. 1603..	16,50	3,18	9,52	
	TPMN	TPMR-33	TPUN	TPUX-R	TPUX-L

For more information see page: A.31

General turning  
Aluminium wheel turning  
Automatic lathes  
Ceramic tools  
Parting and grooving  
Threading  
Drills  
Cartridges  
Brazed tools  
Tooling

Inserts

General turning



**Characteristics:**

Toolholder for face turning and grooving applications equipped with triangular positive inserts and strong cutting edges. The top clamp ensures good rigidity and stability.

**Applications:**



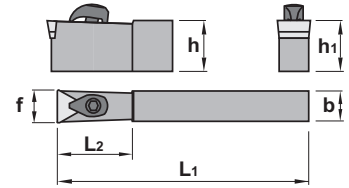
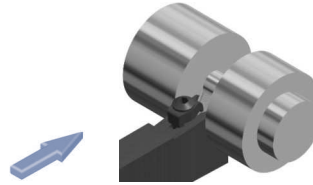

Face turning and grooving toolholder for all kind of materials. The workpiece should be stable.

**Axial:** 6°  
**Radial:** 0°







## CTCPN 90°

Ref.		h=h <sub>1</sub>	b	L <sub>1</sub>	L <sub>2</sub>	f	Insert size	kg
CTCP N	1009 E11	10	9	70	22	11	TP.. 1103..	0,040
	2009 K11	20	9	125	22	11	TP.. 1103..	0,150
	2509 R11	25	9	200	22	11	TP.. 1103..	0,350
CTCP N	2513 R16	25	13	200	28	16	TP.. 1603..	0,500
CTCP N	2518 R22	25	18	200	34	22	TP.. 2204..	0,650
CTCP N	4018 R22	40	18	200	34	22	TP.. 2204..	1,100

Ref.						
CTCP N	1009 E11	2304	5025	-	-	9011-9111
	2009 K11	2304	5025	-	-	9011-9111
	2509 R11	2304	5025	-	-	9011-9111
CTCP N	2513 R16	2305	5003	3116	4002	9016-9116
CTCP N	2518 R22	2211	5004	3122	4012	9022-9122
CTCP N	4018 R22	2211	5004	3122	4012	9022-9122

Ref.	TP..	l	s	d	Positive 11° clearance - Triangular inserts.
	TP.. 1103..	11,00	3,18	6,35	
TP.. 1603..	16,50	3,18	9,52		
TP.. 2204..	22,00	4,76	12,70		

TPMN	TPMR-33	TPUN	TPUX-R	TPUX-L
				

For more information see page: A.31



**Characteristics:**

Toolholder for face turning and grooving applications equipped with triangular positive inserts and strong cutting edges. The top clamp ensures good rigidity and stability.

**Applications:**

Face turning and grooving toolholder for all kind of materials. The workpiece should be stable.

**Axial:** 6°  
**Radial:** 0°

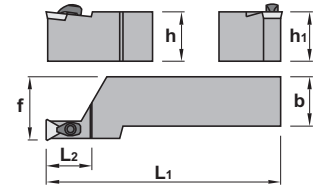
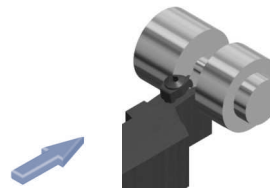

## CTCP 90°

Ref.		h=h <sub>1</sub>	b	L <sub>1</sub>	L <sub>2</sub>	f	Insert size	kg
CTCP R/L 1212 F11	CTCP R/L 1212 F11	12	12	80	22	16	TP.. 1103..	0,070
	CTCP R/L 1616 H11	16	16	100	22	20	TP.. 1103..	0,200
	CTCP R/L 2020 K11	20	20	125	22	25	TP.. 1103..	0,400
	CTCP R/L 2525 M11	25	25	150	22	32	TP.. 1103..	0,700
CTCP R/L 3225 P16	CTCP R/L 3225 P16	32	25	170	28	32	TP.. 1603..	1,000
	CTCP R/L 3232 P16	32	32	170	28	40	TP.. 1603..	1,250
CTCP R/L 3225 P22	CTCP R/L 3225 P22	32	25	170	34	32	TP.. 2204..	1,000
	CTCP R/L 3232 P22	32	32	170	34	40	TP.. 2204..	1,250

Ref.						
CTCP R/L 1212 F11	CTCP R/L 1212 F11	2304	5025	-	-	9011-9111
	CTCP R/L 1616 H11	2304	5025	-	-	9011-9111
	CTCP R/L 2020 K11	2304	5025	-	-	9011-9111
	CTCP R/L 2525 M11	2304	5025	-	-	9011-9111
CTCP R/L 3225 P16	CTCP R/L 3225 P16	2305	5003	3116	4002	9016-9116
	CTCP R/L 3232 P16	2305	5003	3116	4002	9016-9116
CTCP R/L 3225 P22	CTCP R/L 3225 P22	2211	5004	3122	4012	9022-9122
	CTCP R/L 3232 P22	2211	5004	3122	4012	9022-9122

	TP..				Positive 11° clearance - Triangular inserts.	
	Ref.	l	s	d		
	TP.. 1103..	11,00	3,18	6,35		
TP.. 1603..	16,50	3,18	9,52			
TP.. 2204..	22,00	4,76	12,70			
	TPMN	TPMR-33	TPUN	TPUX-R	TPUX-L	

For more information see page: A.31



Inserts

General turning



**Characteristics:**

Toolholder for external turning and chamfering turning applications equipped with triangular positive inserts and strong cutting edges. The top clamp ensures good rigidity and stability.

**Applications:**

External turning and chamfering turning toolholder for all kind of materials. The workpiece should be stable.

For interrupted cut choose toolholder Ref. PTDN (Page: B.55).

**Axial:** 4.25°  
**Radial:** 4.25°

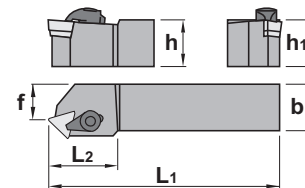
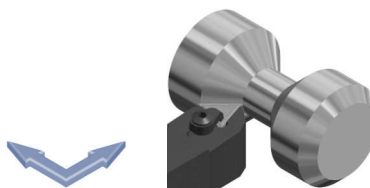

CTDP 45°		h=h <sub>1</sub>	b	L <sub>1</sub>	L <sub>2</sub>	f	Insert size	kg
Ref.	CTDP R/L 1212 F11	12	12	80	20	6,3	TP.. 1103..	0,070
	CTDP R/L 1616 H11	16	16	100	22	10,3	TP.. 1103..	0,200
	CTDP R/L 2020 K16	20	20	125	28	12,2	TP.. 1603..	0,400
	CTDP R/L 2525 M16	25	25	150	28	17,2	TP.. 1603..	0,700
	CTDP R/L 3232 P16	32	32	170	28	23,5	TP.. 1603..	1,250
	CTDP R/L 3232 P22	32	32	170	34	20,5	TP.. 2204..	1,250

Ref.	CTDP R/L 1212 F11	CTDP R/L 1616 H11	CTDP R/L 2020 K16	CTDP R/L 2525 M16	CTDP R/L 3232 P16	CTDP R/L 3232 P22	Supplementary accessories
	2207	2207	2209	2209	2209	2211	
	5025	5025	5003	5003	5003	5004	
	-	-	3116	3116	3116	3122	
	-	-	4002	4002	4002	4012	
	2407	2407	2409	2409	2409	2411	9011-9111 9016-9116 9016-9116 9016-9116 9022-9122

Ref.	TP..	l	s	d	Positive 11° clearance - Triangular inserts.
	TP.. 1103..	11,00	3,18	6,35	
TP.. 1603..	16,50	3,18	9,52		
TP.. 2204..	22,00	4,76	12,70		

TPMN	TPMR-33	TPUN	TPUX-R	TPUX-L

For more information see page: A.31



**Characteristics:**

Toolholder for face turning applications equipped with triangular positive inserts and strong cutting edges. The top clamp ensures good rigidity and stability.

**Applications:**

Face turning toolholder for all kind of materials. The workpiece should be stable.

For interrupted cut choose toolholder Ref. PTFN (Page: B.56).

**Axial:** 6°  
**Radial:** 0°

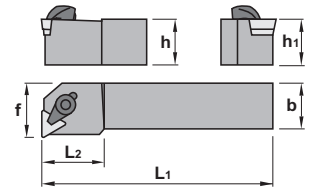
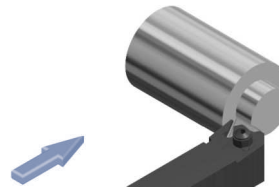

## CTFP 90°

Ref.		h=h1	b	L1	L2	f	Insert size	Kg
CTFP R/L	1010 E11	10	10	70	16	12	TP.. 1103..	0,030
	1212 F11	12	12	80	18	16	TP.. 1103..	0,070
	1616 H11	16	16	100	22	20	TP.. 1103..	0,200
	2020 K11	20	20	125	22	25	TP.. 1103..	0,400
	2020 K16	20	20	125	22	25	TP.. 1603..	0,400
	2525 M16	25	25	150	22	32	TP.. 1603..	0,700
	3225 P16	32	25	170	22	32	TP.. 1603..	1,000
	3232 P16	32	32	170	28	40	TP.. 1603..	1,250
	4040 S16	40	40	250	34	50	TP.. 1603..	3,000
	5050 T16	50	50	300	34	60	TP.. 1603..	5,650
	3232 P22	32	32	170	34	40	TP.. 2204..	1,250
	4040 S22	40	40	250	34	50	TP.. 2204..	3,000
5050 T22	50	50	300	34	60	TP.. 2204..	5,650	

Ref.						
CTFP R/L 1010 E11	2000	5015	-	-	-	-
CTFP R/L 1212 F11	2207	5025	-	-	2407	9011-9111
CTFP R/L 1616 H11	2207	5025	-	-	2407	9011-9111
CTFP R/L 2020 K11	2207	5025	-	-	2407	9011-9111
CTFP R/L 2020 K16	2209	5003	3116	4002	2409	9016-9116
CTFP R/L 2525 M16	2209	5003	3116	4002	2409	9016-9116
CTFP R/L 3225 P16	2209	5003	3116	4002	2409	9016-9116
CTFP R/L 3232 P16	2209	5003	3116	4002	2409	9016-9116
CTFP R/L 4040 S16	2209	5003	3116	4002	2409	9016-9116
CTFP R/L 5050 T16	2209	5003	3116	4002	2409	9016-9116
CTFP R/L 3232 P22	2211	5004	3122	4012	2411	9022-9122
CTFP R/L 4040 S22	2211	5004	3122	4012	2411	9022-9122
CTFP R/L 5050 T22	2211	5004	3122	4012	2411	9022-9122

Supplementary accessories

Ref.	TP..	l	s	d	Positive 11° clearance - Triangular inserts.
	TP.. 1103..	11,00	3,18	6,35	
TP.. 1603..	16,50	3,18	9,52		
TP.. 2204..	22,00	4,76	12,70		

  

TPMN	TPMR-33	TPUN	TPUX-R	TPUX-L

For more information see page: A.31

Inserts

General turning

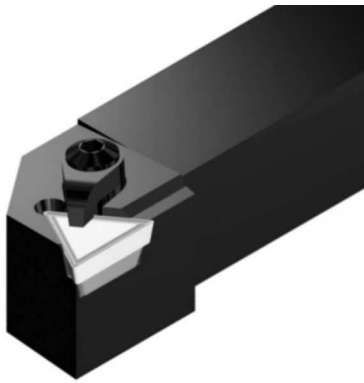

**Characteristics:**

Toolholder for external turning applications equipped with triangular positive inserts and strong cutting edges. The top clamp ensures good rigidity and stability.

**Applications:**

External turning toolholder for all kind of materials. The workpiece should be stable.

For interrupted cut choose toolholder Ref. PTGN (Page: B.57).

**Axial:** 0°  
**Radial:** 6°

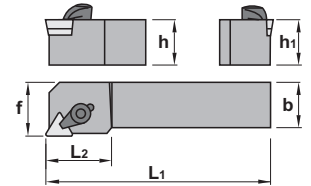
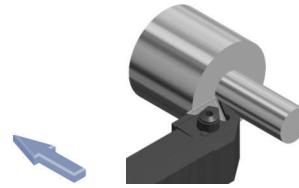

# CTGP 90°

Ref.		h=h1	b	L1	L2	f	Insert size	kg
Ref.	CTGP R/L 1010 E11	10	10	70	16	12	TP.. 1103..	0,030
	CTGP R/L 1212 F11	12	12	80	18	16	TP.. 1103..	0,070
	CTGP R/L 1616 H11	16	16	100	22	20	TP.. 1103..	0,200
	CTGP R/L 2020 K11	20	20	125	22	25	TP.. 1103..	0,400
	CTGP R/L 2020 K16	20	20	125	28	25	TP.. 1603..	0,400
	CTGP R/L 2525 M16	25	25	150	28	32	TP.. 1603..	0,700
	CTGP R/L 3225 P16	32	25	170	28	32	TP.. 1603..	1,000
	CTGP R/L 3232 P22	32	32	170	34	40	TP.. 2204..	1,250
	CTGP R/L 4040 S22	40	40	250	34	50	TP.. 2204..	3,000
	CTGP R/L 5050 T22	50	50	300	34	60	TP.. 2204..	5,650

Ref.							
Ref.	CTGP R/L 1010 E11	2000	5015	-	-	-	-
	CTGP R/L 1212 F11	2207	5025	-	-	2407	9011-9111
	CTGP R/L 1616 H11	2207	5025	-	-	2407	9011-9111
	CTGP R/L 2020 K11	2207	5025	-	-	2407	9011-9111
	CTGP R/L 2020 K16	2209	5003	3116	4002	2409	9016-9116
	CTGP R/L 2525 M16	2209	5003	3116	4002	2409	9016-9116
	CTGP R/L 3225 P16	2209	5003	3116	4002	2409	9016-9116
	CTGP R/L 3232 P22	2211	5004	3122	4012	2411	9022-9122
	CTGP R/L 4040 S22	2211	5004	3122	4012	2411	9022-9122
	CTGP R/L 5050 T22	2211	5004	3122	4012	2411	9022-9122

Supplementary accessories

Ref.	TP..	l	s	d	Positive 11° clearance - Triangular inserts.
	TP.. 1103..	11,00	3,18	6,35	
TP.. 1603..	16,50	3,18	9,52		
TP.. 2204..	22,00	4,76	12,70		

TPMN	TPMR-33	TPUN	TPUX-R	TPUX-L

For more information see page: A.31

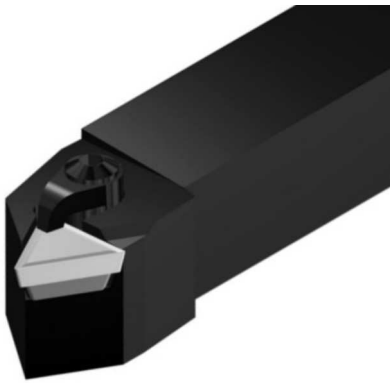

**Characteristics:**

Toolholder for external turning and chamfering turning applications equipped with triangular positive inserts and strong cutting edges. The top clamp ensures good rigidity and stability.

**Applications:**

External turning and chamfering turning toolholder for all kind of materials. The workpiece should be stable.

For interrupted cut choose toolholder Ref. PTTN (Page: B.58).

**Axial:** 3°  
**Radial:** 5.25°

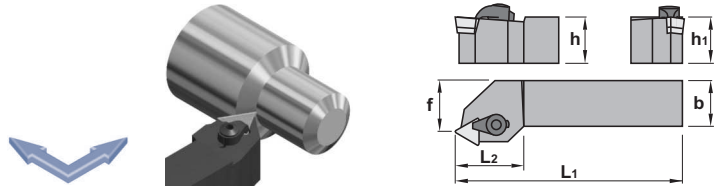

## CTTP 60°

Ref.		h=h1	b	L1	L2	f	Insert size	kg
CTTP R/L 0808 D09	CTTP R/L 0808 D09	8	8	60	16	7	TP.. 0902..	0,020
	CTTP R/L 1010 E09	10	10	70	16	9	TP.. 0902..	0,030
CTTP R/L 1010 E11	CTTP R/L 1010 E11	10	10	70	16	9	TP.. 1103..	0,030
	CTTP R/L 1212 F11	12	12	80	18	11	TP.. 1103..	0,070
CTTP R/L 1616 H11	CTTP R/L 1616 H11	16	16	100	22	13	TP.. 1103..	0,200
	CTTP R/L 2020 K11	20	20	125	22	17	TP.. 1103..	0,400
CTTP R/L 2020 K16	CTTP R/L 2020 K16	20	20	125	28	17	TP.. 1603..	0,400
	CTTP R/L 2525 M16	25	25	150	28	22	TP.. 1603..	0,700

Ref.							
CTTP R/L 0808 D09	CTTP R/L 0808 D09	2000	5015	-	-	-	-
	CTTP R/L 1010 E09	2000	5015	-	-	-	-
CTTP R/L 1010 E11	CTTP R/L 1010 E11	2000	5015	-	-	-	-
	CTTP R/L 1212 F11	2207	5025	-	-	2407	9011-9111
CTTP R/L 1616 H11	CTTP R/L 1616 H11	2207	5025	-	-	2407	9011-9111
	CTTP R/L 2020 K11	2207	5025	-	-	2407	9011-9111
CTTP R/L 2020 K16	CTTP R/L 2020 K16	2209	5003	3116	4002	2409	9016-9116
	CTTP R/L 2525 M16	2209	5003	3116	4002	2409	9016-9116

Supplementary accessories

Ref.	TP..	l	s	d	Positive 11° clearance - Triangular inserts.
	TP.. 0902..	9,62	2,38	5,55	
TP.. 1103..	11,00	3,18	6,35		
TP.. 1603..	16,50	3,18	9,52		

TPMN	TPMR-33	TPUN	TPUX-R	TPUX-L

For more information see page: A.31



Inserts

General turning

# (D) Dimple lock

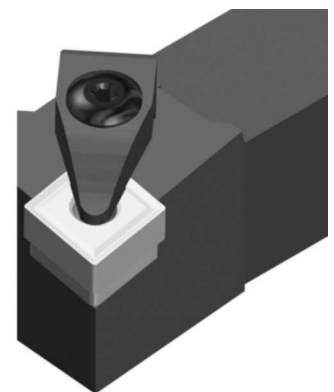
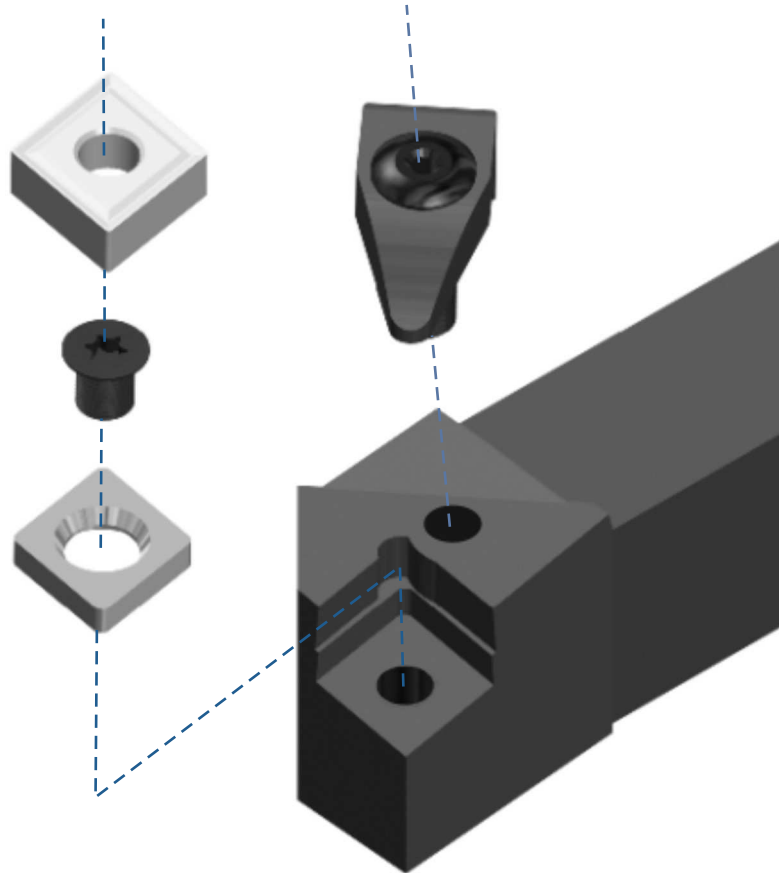

The "D" clamping system avoids insert movement during high feed or heavily interrupted machining, due to its accurate indexing that holds the insert securely clamped.

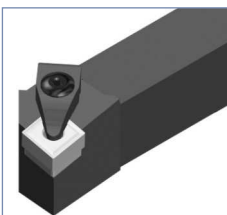

DCLN 95°

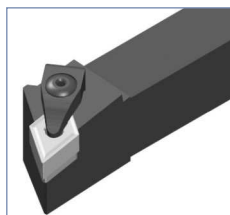

DDJN 93°

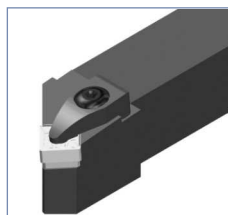

DSSN 45°

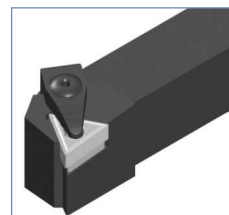

DTGN 90°

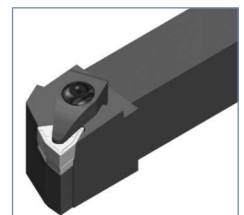

DWLN 95°

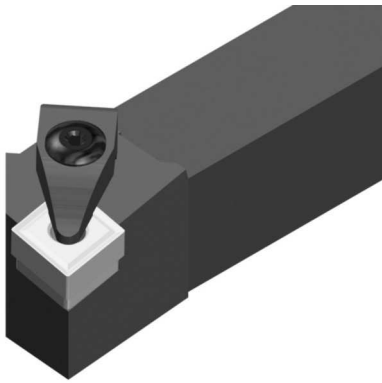

**Characteristics:**

Multipurpose toolholder equipped with rhombic negative double side insert (angle 80°) with strong cutting edge. The dimple lock ensures good rigidity and chip flow in roughing applications.

**Applications:**

External turning toolholder for general applications, roughing, semi-finishing and finishing.

For low powered machines and small pieces choose toolholder Ref. SCLC (Page: B.61).

**Axial:** -6.5°  
**Radial:** -6.5°

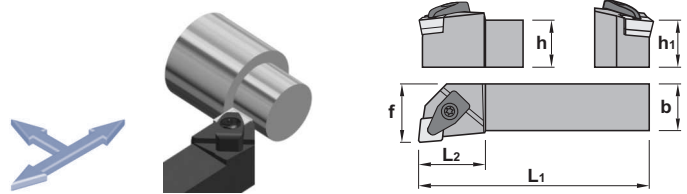

## DCLN 95°

Ref.		h=h <sub>1</sub>	b	L <sub>1</sub>	L <sub>2</sub>	f	Insert size	kg
DCLN R/L	DCLN R/L 2020 K12	20	20	125	28	25	CN.. 1204..	0,400
	DCLN R/L 2525 M12	25	25	150	28	32	CN.. 1204..	0,750
	DCLN R/L 3232 P12	32	32	170	28	40	CN.. 1204..	1,300
DCLN R/L	DCLN R/L 3232 P19	32	32	170	42	40	CN.. 1906..	1,300
	DCLN R/L 4040 S19	40	40	250	43	50	CN.. 1906..	3,050

Ref.							
DCLN R/L	DCLN R/L 2020 K12	ICSN-432	1160	2312	1907	4295	5004
	DCLN R/L 2525 M12	ICSN-432	1160	2312	1907	4295	5004
	DCLN R/L 3232 P12	ICSN-432	1160	2312	1907	4295	5004
DCLN R/L	DCLN R/L 3232 P19	3619	1182	2319	1907	4295	5004
	DCLN R/L 4040 S19	3619	1182	2319	1907	4295	5004

	CN..				Negative 80° rhombic inserts.			
	Ref.	l	s	d	For more information see page: A.18			
	CN.. 1204..	12,90	4,76	12,70	CNMG-CF	CNMG-CM	CNMG-CR	CNMG-CS
	CN.. 1906..	19,30	6,35	19,05				
	CNGP	CNMA	CNMG-CFM	CNMG-CFC	CNMG-CMC	CNMG-CMF	CNMG-CMR	CNMM

Inserts

General turning

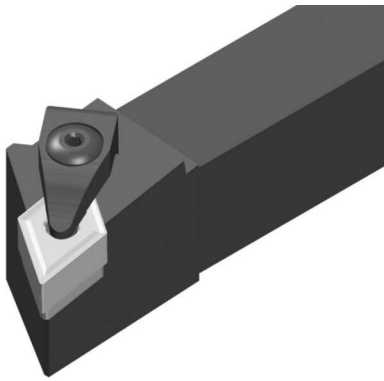

**Characteristics:**

Turning and profiling toolholder equipped with rhombic negative double side insert (angle 55°) with strong cutting edge.

The dimple lock ensures good rigidity and chip flow in roughing applications.

**Applications:**

External turning toolholder for general applications, roughing, semi-finishing and finishing.

For low powered machines and small pieces choose toolholder Ref. SDJC (Page: B.62).

**Axial:** 6.25°  
**Radial:** -6.75°

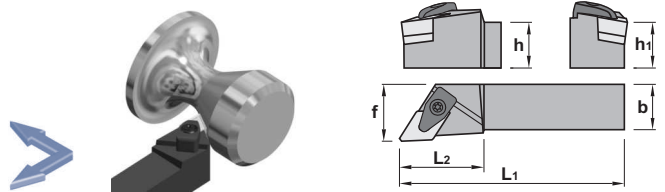

DDJN 93°		h=h <sub>1</sub>	b	L <sub>1</sub>	L <sub>2</sub>	f	Insert size	kg
Ref.	DDJN R/L 2020 K15	20	20	125	34	25	DN.. 1506..	0,400
	DDJN R/L 2525 M15	25	25	150	34	32	DN.. 1506..	0,750
	DDJN R/L 3232 P15	32	32	170	34	40	DN.. 1506..	1,300

Ref.	DDJN R/L 2020 K15	DDJN R/L 2525 M15	DDJN R/L 3232 P15	IDSN 432	1160	2312	1907	4295	5004

	DN..				Negative 55° rhombic inserts.		For more information see page: A.22	
	Ref.	DN.. 1506..	l	s	d	DNMG-CF	DNMG-CM	
	DNGP	DNMA	DNMG-CFM	DNMG-CMR	DNMX			

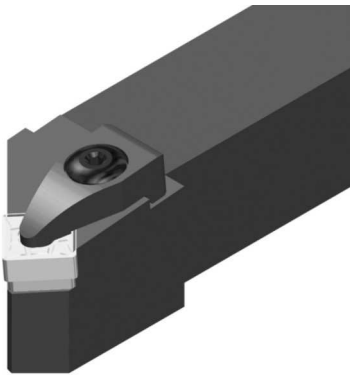

**Characteristics:**

Toolholder for external turning and chamfering applications equipped with square negative inserts and strong cutting edges.

The dimple lock ensures good rigidity and chip flow in roughing applications.

**Applications:**

External turning and chamfering toolholder for general applications, roughing, semi-finishing and finishing.

For low powered machines and small pieces choose toolholder Ref. C SSP (Page: B.11) or SSSC (Page: B.67).

**Axial:** -5.75°  
**Radial:** -5.75°

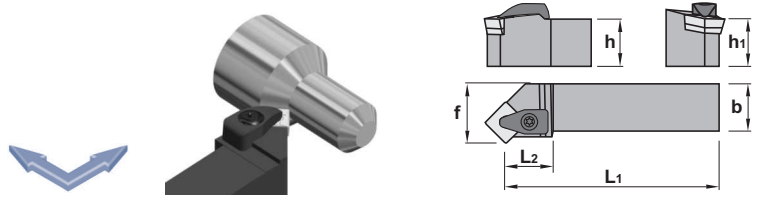

## DSSN 45°

Ref.		h=h <sub>1</sub>	b	L <sub>1</sub>	L <sub>2</sub>	f	Insert size	kg
DSSN R/L 2020 K12	DSSN R/L 2020 K12	20	20	125	28	25	SNM.. 1204..	0,400
	DSSN R/L 2525 M12	25	25	150	28	32	SNM.. 1204..	0,750
	DSSN R/L 3225 P12	32	25	170	28	32	SNM.. 1204..	1,050
DSSN R/L 3232 P19	DSSN R/L 3232 P19	32	32	170	42	40	SNM.. 1906..	1,300
	DSSN R/L 4040 S19	40	40	250	45	50	SNM.. 1906..	3,050

Ref.							
DSSN R/L 2020 K12	DSSN R/L 2020 K12	ISSN-432	1160	2312	1907	4295	5004
	DSSN R/L 2525 M12	ISSN-432	1160	2312	1907	4295	5004
	DSSN R/L 3225 P12	ISSN-432	1160	2312	1907	4295	5004
DSSN R/L 3232 P19	DSSN R/L 3232 P19	3519	1182	2319	1907	4295	5004
	DSSN R/L 4040 S19	3519	1182	2319	1907	4295	5004

	SNM..				Negative square inserts.				
	Ref.	SNM.. 1204..	SNM.. 1906..	l	s	d	For more information see page: A.27		
							SNMG-CR		
	SNMA	SNMG-CFM	SNMG-CMR	SNMM					

Inserts

General turning

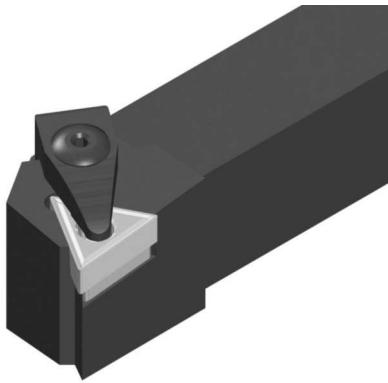

**Characteristics:**

Toolholder for external turning applications equipped with triangular negative inserts and strong cutting edges. The dimple lock ensures good rigidity and chip flow in roughing applications.

**Applications:**

External turning toolholder for general applications, roughing, semi-finishing and finishing.

For low powered machines and small pieces choose toolholder Ref. CTGP (Page: B.18) or STGC (Page: B.71).

**Axial:** -6°  
**Radial:** -6°

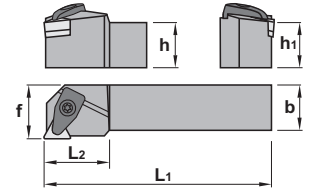
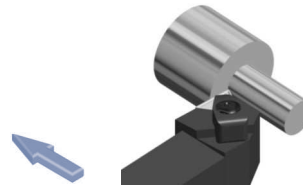

DTGN 90°		h=h <sub>1</sub>	b	L <sub>1</sub>	L <sub>2</sub>	f	Insert size	kg
Ref.	DTGN R/L 2020 K16	20	20	125	28	25	TNM.. 1604..	0,400
	DTGN R/L 2525 M16	25	25	150	28	32	TNM.. 1604..	0,750
	DTGN R/L 2525 M22	25	25	150	34	32	TNM.. 2204..	0,750
	DTGN R/L 3232 P22	32	32	170	34	40	TNM.. 2204..	1,300

Ref.	DTGN R/L 2020 K16	DTGN R/L 2525 M16	DTGN R/L 2525 M22	DTGN R/L 3232 P22	ITSN-322	ITSN-322	ITSN-433	ITSN-433	1150	1150	1160	1160	2308	2308	2312	2312	1915	1915	1907	1907	4294	4294	4295	4295	5025	5025	5004	5004	

Ref.	TNM..				Negative triangular inserts.																							
					For more information see page: A.29																							
	TNM.. 1604..	TNM.. 2204..	l	s	d	TNMG-CF	TNMG-CM	TNMG-CS	TNMG-CF	TNMG-CM	TNMG-CS	TNMG-CF	TNMG-CM	TNMG-CS														

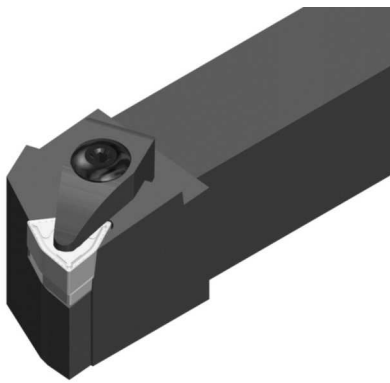

**Characteristics:**

Multipurpose toolholder equipped with trigon negative double side insert (angle 80°) with strong cutting edge. The dimple lock ensures good rigidity and chip flow in roughing applications.

**Applications:**

External turning toolholder for general applications, roughing, semi-finishing and finishing.

Top clamp toolholder Ref. MWLN (Page: B.38) or MWLN-K (Page: B.39).

**Axial:** -6°  
**Radial:** -6°

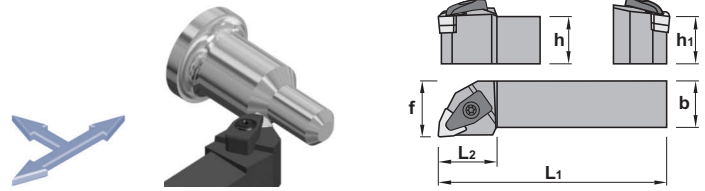

## DWLN 95°

Ref.		h=h <sub>1</sub>	b	L <sub>1</sub>	L <sub>2</sub>	f	Insert size	kg
DWLN R/L 2020 K08		20	20	125	34	25	WNMG 0804..	0,400
DWLN R/L 2525 M08		25	25	150	34	32	WNMG 0804..	0,750
DWLN R/L 3232 P08		32	32	170	34	40	WNMG 0804..	1,300

Ref.						
DWLN R/L 2020 K08	IWSN-433	1160	2312	1907	4295	5004
DWLN R/L 2525 M08	IWSN-433	1160	2312	1907	4295	5004
DWLN R/L 3232 P08	IWSN-433	1160	2312	1907	4295	5004

	WNMG				Negative 80° trigon inserts.		
	Ref.	l	s	d	WNMG-CF	WNMG-CM	WNMG-CS
	WNMG 0804..	8,14	4,76	12,70			
	WNMG-CFM	WNMG-CMC	WNMG-CMF	WNMG-CMR			



Inserts

General turning



**Characteristics:**

Multipurpose toolholder equipped with rhombic negative double side insert (angle 80°) with strong cutting edge. The center pin and top clamp ensure good rigidity and stability in roughing applications.

**Applications:**

External turning toolholder for general applications, roughing, semi-finishing and finishing. Not suitable for cermet, ceramic and K10, P10 grade inserts.



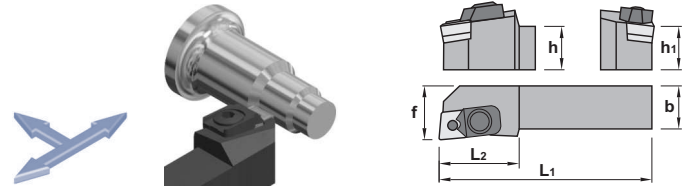

For low powered machines and small pieces choose toolholder Ref. SCLC (Page: B.61).













**Axial:** -8°  
**Radial:** -6.5°



## MCLN 95°

Ref.		h=h <sub>1</sub>	b	L <sub>1</sub>	L <sub>2</sub>	f	Insert size	kg
MCLN R/L 2020 K12	MCLN R/L 2020 K12	20	20	125	34	25	CN.. 1204..	0,450
	MCLN R/L 2525 M12	25	25	150	34	32	CN.. 1204..	0,800
	MCLN R/L 3225 P12	32	25	170	34	32	CN.. 1204..	1,200
MCLN R/L 2525 M19	MCLN R/L 2525 M19	25	25	150	42	32	CN.. 1906..	0,800
	MCLN R/L 3225 P19	32	25	170	42	32	CN.. 1906..	1,200
	MCLN R/L 4040 S19	40	40	250	42	50	CN.. 1906..	3,100

Ref.						
MCLN R/L 2020 K12	MCLN R/L 2020 K12	2015	5005	ICSN-432	1661	1394
	MCLN R/L 2525 M12	2015	5005	ICSN-432	1661	1394
	MCLN R/L 3225 P12	2015	5005	ICSN-432	1661	1394
MCLN R/L 2525 M19	MCLN R/L 2525 M19	2024	5005	3619	1682	1296
	MCLN R/L 3225 P19	2024	5005	3619	1682	1296
	MCLN R/L 4040 S19	2024	5005	3619	1682	1296

Ref.	CN..				Negative 80° rhombic inserts.			
	CN.. 1204..	l	s	d	CNMG-CF	CNMG-CM	CNMG-CR	CNMG-CS
	CN.. 1906..	12,90	4,76	12,70				
		19,30	6,35	19,05				
								

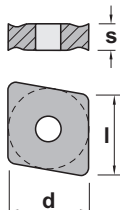

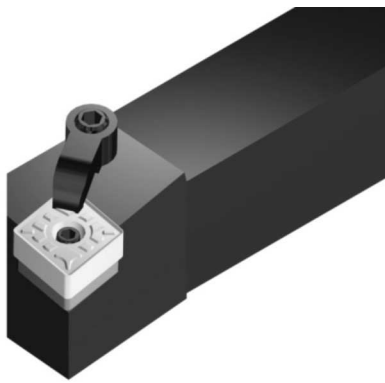

**Characteristics:**

Multipurpose toolholder equipped with rhombic negative double side insert (angle 80°) with strong cutting edge. The center pin and top clamp ensure good rigidity and stability in roughing applications.

**Applications:**

External turning toolholder for general applications, roughing, semi-finishing and finishing. Specially recommended for cermet, ceramic and K10, P10 grade inserts.

For low powered machines and small pieces choose toolholder Ref. SCLC (Page: B.61).

**Axial:** -8°  
**Radial:** -6.25°

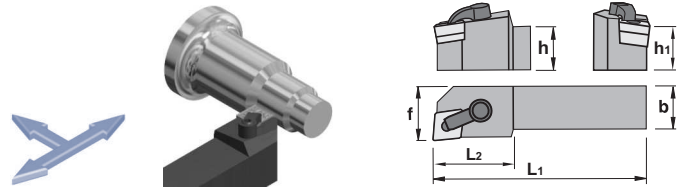

## MCLN-K 95°

Ref.		h=h <sub>1</sub>	b	L <sub>1</sub>	L <sub>2</sub>	f	Insert size	Kg
MCLN R/L 2020 K12-K	MCLN R/L 2020 K12-K	20	20	125	28	25	CN.. 1204..	0,450
	MCLN R/L 2525 M12-K	25	25	150	28	32	CN.. 1204..	0,800
	MCLN R/L 3225 P12-K	32	25	170	28	32	CN.. 1204..	1,200
MCLN R/L 2525 M19-K	MCLN R/L 2525 M19-K	25	25	150	42	32	CN.. 1906..	0,800
	MCLN R/L 3232 P19-K	32	32	170	42	40	CN.. 1906..	1,400

Ref.							
MCLN R/L 2020 K12-K	MCLN R/L 2020 K12-K	2613	1086	5003	ICSN-432	1656	5025
	MCLN R/L 2525 M12-K	2613	1086	5003	ICSN-432	1656	5025
	MCLN R/L 3225 P12-K	2613	1086	5003	ICSN-432	1656	5025
MCLN R/L 2525 M19-K	MCLN R/L 2525 M19-K	2621	1098	5004	ICSN-634	1670	5004
	MCLN R/L 3232 P19-K	2621	1098	5004	ICSN-634	1670	5004

	CN..				Negative 80° rhombic inserts.			
	Ref.	l	s	d	For more information see page: A.18			
	CN.. 1204..	12,90	4,76	12,70	CNMG-CF	CNMG-CM	CNMG-CR	CNMG-CS
	CN.. 1906..	19,30	6,35	19,05				
	CNGP	CNMA	CNMG-CFM	CNMG-CFC	CNMG-CMC	CNMG-CMF	CNMG-CMR	CNMM

Inserts

General turning

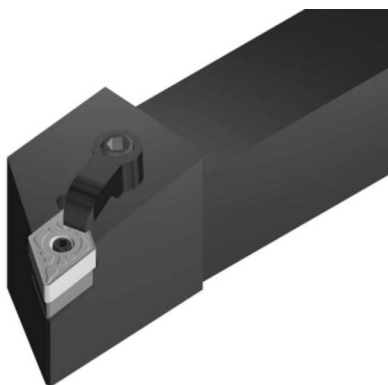

**Characteristics:**

Turning and profiling toolholder equipped with rhombic negative double side insert (angle 55°) with strong cutting edge. The center pin and top clamp ensure good rigidity and stability in roughing applications.

**Applications:**

External turning toolholder for general applications, roughing, semi-finishing and finishing.

For low powered machines and small pieces choose toolholder Ref. SDJC (Page: B.62).

**Axial:** -6°  
**Radial:** -7°

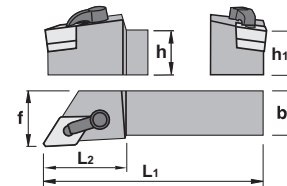
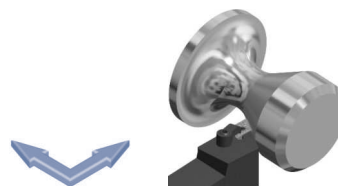

# MDJN-K 93°

Ref.		h=h <sub>1</sub>	b	L <sub>1</sub>	L <sub>2</sub>	f	Insert size	kg
	MDJN R/L 2020 K15-K	20	20	125	34	25	DN.. 1506..	0,450
	MDJN R/L 2525 M15-K	25	25	150	34	32	DN.. 1506..	0,800
	MDJN R/L 3225 P15-K	32	25	170	34	32	DN.. 1506..	1,200

Ref.							
	MDJN R/L 2020 K15-K	2614	1086	5003	IDSN-432	1666	5025
	MDJN R/L 2525 M15-K	2614	1086	5003	IDSN-432	1666	5025
	MDJN R/L 3225 P15-K	2614	1086	5003	IDSN-432	1666	5025

Ref.	DN..				Negative 55° rhombic inserts.		For more information see page: A.22	
	DN.. 1506..	l	s	d	DNMG-CF	DNMG-CM		
		15,50	6,35	12,70				
	DNGP	DNMA	DNMG-CFM	DNMG-CMR	DNMX			

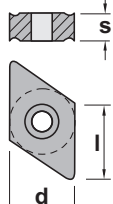

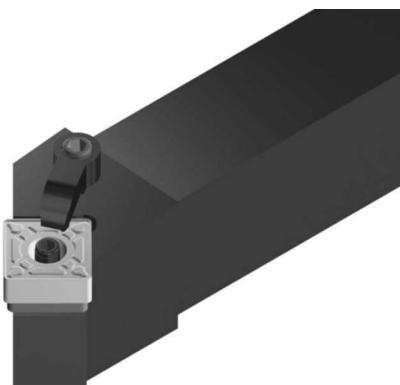

**Characteristics:**

Toolholder for external turning and chamfering applications equipped with square negative inserts and strong cutting edges. The center pin and top clamp ensure good rigidity and stability in roughing applications.

**Applications:**

External turning and chamfering toolholder for general applications, roughing, semi-finishing and finishing.

For low powered machines and small pieces choose toolholder Ref. CSSP (Page: B.11) or SSSC (Page: B.67).

**Axial:** -6°  
**Radial:** -6°

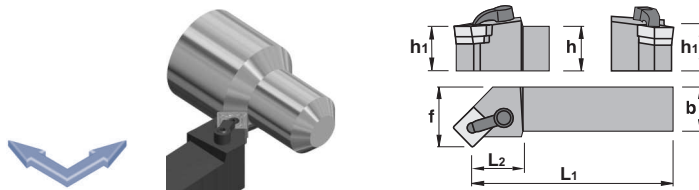

## MSSN-K 45°

Ref.		h=h1	b	L1	L2	f	Insert size	Kg
MSSN R/L 2020 K12-K		20	20	125	28	27	SNM.. 1204..	0,450
MSSN R/L 2525 M12-K		25	25	150	28	32	SNM.. 1204..	0,800

Ref.							
MSSN R/L 2020 K12-K		2613	1086	5003	ISSN-432	1656	5025
MSSN R/L 2525 M12-K		2613	1086	5003	ISSN-432	1656	5025

	SNM..				Negative square inserts.				
	Ref.	SNM.. 1204..	l	s	d	For more information see page: A.27			
			12,70	4,76	12,70	SNMG-CR			
	SNMA	SNMG-CFM	SNMG-CMR						

General turning  
 Aluminium wheel turning  
 Automatic lathes  
 Ceramic tools  
 Parting and grooving  
 Threading  
 Drills  
 Cartridges  
 Brazed tools  
 Tooling

Inserts

General turning

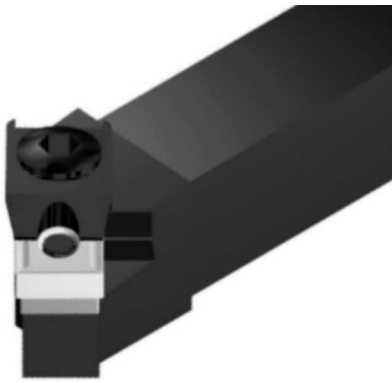

**Characteristics:**

Toolholder for external turning and chamfering applications equipped with square negative inserts and strong cutting edges. The center pin and top clamp ensure good rigidity and stability in roughing applications.

**Applications:**

External turning and chamfering toolholder for general applications, roughing, semi-finishing and finishing.

For low powered machines and small pieces choose toolholder Ref. CSSP (Page: B.11) or SSSC (Page: B.67).

**Axial:** -6°  
**Radial:** -6°

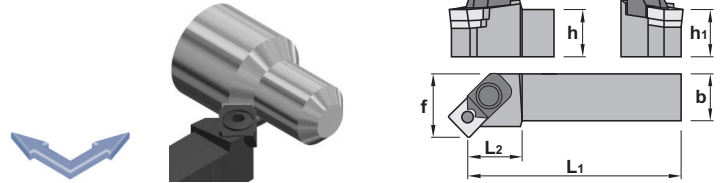

MSSN 45°		h=h <sub>1</sub>	b	L <sub>1</sub>	L <sub>2</sub>	f	Insert size	kg
Ref.	MSSN R/L 2020 K12	20	20	125	34	27	SNM.. 1204..	0,450
	MSSN R/L 2525 M12	25	25	150	34	32	SNM.. 1204..	0,800
	MSSN R/L 3225 P12	32	25	170	34	32	SNM.. 1204..	1,200
Ref.	MSSN R/L 2525 M19	25	25	150	42	32	SNM.. 1906..	0,800
	MSSN R/L 3225 P19	32	25	170	42	32	SNM.. 1906..	1,200
	MSSN R/L 3232 P19	32	32	170	42	40	SNM.. 1906..	1,400
	MSSN R/L 4040 S19	40	40	250	42	50	SNM.. 1906..	3,100

Ref.						
Ref.	MSSN R/L 2020 K12	2014	5005	3514	1661	1394
	MSSN R/L 2525 M12	2014	5005	3514	1661	1394
	MSSN R/L 3225 P12	2014	5005	3514	1661	1394
Ref.	MSSN R/L 2525 M19	2024	5005	3519	1682	1296
	MSSN R/L 3225 P19	2024	5005	3519	1682	1296
	MSSN R/L 3232 P19	2024	5005	3519	1682	1296
	MSSN R/L 4040 S19	2024	5005	3519	1682	1296

Ref.	SNM..	l	s	d	Negative square inserts.			
	Ref.	SNM.. 1204..	12,70	4,76	12,70	For more information see page: A.27		
	SNM.. 1906..	19,05	6,35	19,05				
	SNMA	SNMG-CFM	SNMG-CMR	SNMM				

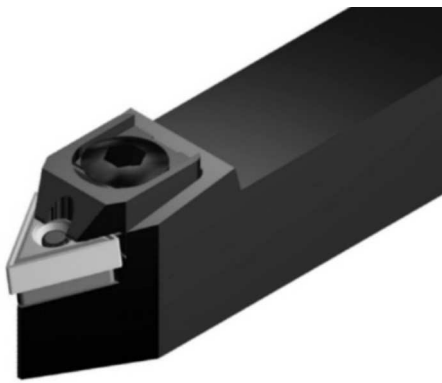

**Characteristics:**

Profiling toolholder equipped with triangular negative double side insert (angle 60°) with strong cutting edge. The clamp fixing ensures good rigidity and stability in roughing applications.

**Applications:**

Profiling toolholder for general applications, roughing, semi-finishing and finishing.

**Axial:** -8.25°  
**Radial:** -2.25°

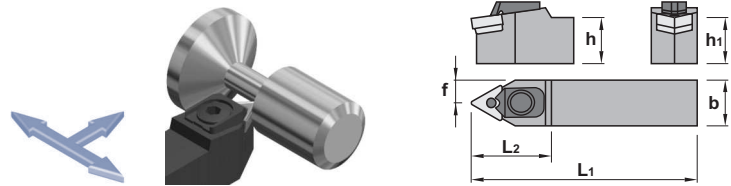

## MTEN 60°

Ref.		h=h1	b	L1	L2	f	Insert size	Kg
MTEN R/L/N 2020 K16	MTEN R/L/N 2020 K16	20	20	125	34	10,5	TNM.. 1604..	0,450
	MTEN R/L/N 2525 M16	25	25	150	34	13,0	TNM.. 1604..	0,800
	MTEN R/L/N 3225 P16	32	25	170	34	13,0	TNM.. 1604..	1,200
MTEN R/L/N 2525 M22	MTEN R/L/N 2525 M22	25	25	150	42	13,0	TNM.. 2204..	0,800
	MTEN R/L/N 3225 P22	32	25	170	42	13,0	TNM.. 2204..	1,200
	MTEN R/L/N 3232 P22	32	32	170	42	16,5	TNM.. 2204..	1,400
MTEN R/L/N 4025 R22	MTEN R/L/N 4025 R22	40	25	200	42	13,0	TNM.. 2204..	1,500
	MTEN R/L/N 5032 S22	50	32	250	45	16,5	TNM.. 2204..	2,950

Ref.					
MTEN R/L/N 2020 K16	MTEN R/L/N 2020 K16	2014	5005	3414	1642
	MTEN R/L/N 2525 M16	2014	5005	3414	1642
	MTEN R/L/N 3225 P16	2014	5005	3414	1642
MTEN R/L/N 2525 M22	MTEN R/L/N 2525 M22	2024	5005	ITSN-433	1661
	MTEN R/L/N 3225 P22	2024	5005	ITSN-433	1661
	MTEN R/L/N 3232 P22	2024	5005	ITSN-433	1661
MTEN R/L/N 4025 R22	MTEN R/L/N 4025 R22	2024	5005	ITSN-433	1661
	MTEN R/L/N 5032 S22	2024	5005	ITSN-433	1661

	TNM..				Negative triangular inserts.			
	Ref.	l	s	d	For more information see page: A.29			
	TNM.. 1604..	16,50	4,76	9,52	TNMG-CF	TNMG-CM	TNMG-CS	
	TNM.. 2204..	22,00	4,76	12,70				
	TNMA	TNMG-CFC	TNMG-CFM	TNMG-CMC	TNMG-CMF	TNMG-CMR	TNMX-R	TNMX-L



Inserts

General turning

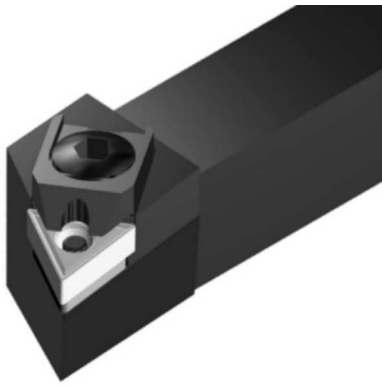

**Characteristics:**

Turning and profiling toolholder equipped with triangular negative double side insert with strong cutting edge. The center pin and top clamp ensure good rigidity and stability in roughing applications.

**Applications:**

External turning and profiling toolholder for general applications, roughing, semi-finishing and finishing. Not suitable for cermet, ceramic and K10, P10 grade inserts.

For low powered machines and small pieces choose toolholder Ref. STJC (Page: B.72).

**Axial:** -6°  
**Radial:** -6°

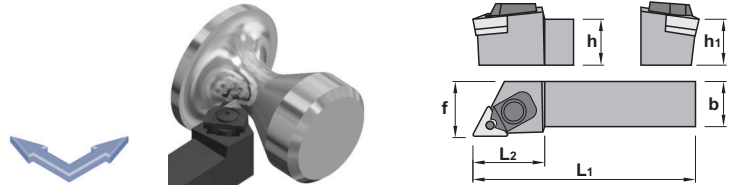

MTJN 93°		h=h1	b	L1	L2	f	Insert size	kg
Ref.	MTJN R/L 2020 K16	20	20	125	34	25	TNM.. 1604..	0,450
	MTJN R/L 2525 M16	25	25	150	34	32	TNM.. 1604..	0,800
	MTJN R/L 3225 P16	32	25	170	34	32	TNM.. 1604..	1,200
Ref.	MTJN R/L 2525 M22	25	25	150	38	32	TNM.. 2204..	0,800
	MTJN R/L 3225 P22	32	25	170	42	32	TNM.. 2204..	1,200
	MTJN R/L 3232 P22	32	32	170	42	40	TNM.. 2204..	1,400
	MTJN R/L 4025 R22	40	25	200	42	32	TNM.. 2204..	1,500
	MTJN R/L 5032 S22	50	32	250	42	40	TNM.. 2204..	2,950

Ref.						
Ref.	MTJN R/L 2020 K16	2014	5005	3414	1642	1393
	MTJN R/L 2525 M16	2014	5005	3414	1642	1393
	MTJN R/L 3225 P16	2014	5005	3414	1642	1393
	MTJN R/L 2525 M22	2024	5005	ITSN-433	1661	1394
	MTJN R/L 3225 P22	2024	5005	ITSN-433	1661	1394
	MTJN R/L 3232 P22	2024	5005	ITSN-433	1661	1394
	MTJN R/L 4025 R22	2024	5005	ITSN-433	1661	1394
	MTJN R/L 5032 S22	2024	5005	ITSN-433	1661	1394

Ref.	TNM..			Negative triangular inserts.			
	TNM.. 1604..	l	s	d	TNMG-CF	TNMG-CM	TNMG-CS
	TNM.. 2204..	16,50	4,76	9,52			
		22,00	4,76	12,70			
	TNMA	TNMG-CFC	TNMG-CFM	TNMG-CMC	TNMG-CMF	TNMG-CMR	TNMX-R
							TNMX-L

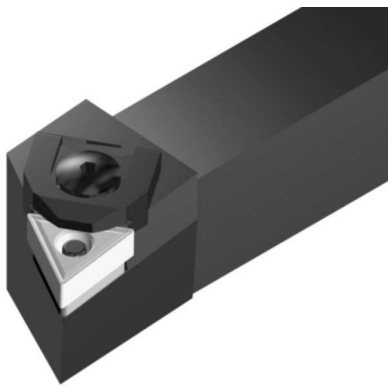

**Characteristics:**

Turning and profiling toolholder equipped with triangular negative double side insert with strong cutting edge. The center pin and top clamp ensure good rigidity and stability in roughing applications.

**Applications:**

External turning and profiling toolholder for general applications, roughing, semi-finishing and finishing. Specially recommended for cermet, ceramic and K10, P10 grade inserts.

For low powered machines and small pieces choose toolholder Ref. STJC (Page: B.72).

**Axial:** -6°  
**Radial:** -6°

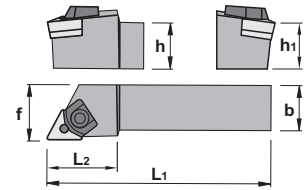
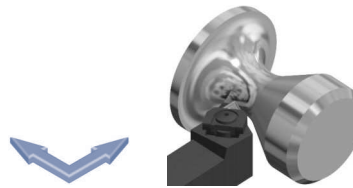

# MTJN-K 93°

Ref.		h=h <sub>1</sub>	b	L <sub>1</sub>	L <sub>2</sub>	f	Insert size	kg
MTJN R/L 2020 K16-K	MTJN R/L 2020 K16-K	20	20	125	34	25	TNM.. 1604..	0,450
	MTJN R/L 2525 M16-K	25	25	150	34	32	TNM.. 1604..	0,800
MTJN R/L 2525 M22-K	MTJN R/L 2525 M22-K	25	25	150	34	32	TNM.. 2204..	0,800
MTJN R/L 3225 P22-K	MTJN R/L 3225 P22-K	32	25	170	34	32	TNM.. 2204..	1,200
MTJN R/L 3232 P22-K	MTJN R/L 3232 P22-K	32	32	170	42	40	TNM.. 2204..	1,400
MTJN R/L 4025 R22-K	MTJN R/L 4025 R22-K	40	25	200	34	32	TNM.. 2204..	1,500
MTJN R/L 5032 S22-K	MTJN R/L 5032 S22-K	50	32	250	34	40	TNM.. 2204..	2,950

Ref.					
MTJN R/L 2020 K16-K	MTJN R/L 2020 K16-K	2017	5025	3414	1642
	MTJN R/L 2525 M16-K	2017	5025	3414	1642
MTJN R/L 2525 M22-K	MTJN R/L 2525 M22-K	2023	5003	ITSN-433	1661
MTJN R/L 3225 P22-K	MTJN R/L 3225 P22-K	2023	5003	ITSN-433	1661
MTJN R/L 3232 P22-K	MTJN R/L 3232 P22-K	2023	5003	ITSN-433	1661
MTJN R/L 4025 R22-K	MTJN R/L 4025 R22-K	2023	5003	ITSN-433	1661
MTJN R/L 5032 S22-K	MTJN R/L 5032 S22-K	2023	5003	ITSN-433	1661

	TNM..				Negative triangular inserts.			
	Ref.	l	s	d	For more information see page: A.29			
	TNM.. 1604..	16,50	4,76	9,52	TNMG-CF	TNMG-CM	TNMG-CS	
	TNM.. 2204..	22,00	4,76	12,70				
	TNMA	TNMG-CFC	TNMG-CFM	TNMG-CMC	TNMG-CMF	TNMG-CMR	TNMX-R	TNMX-L

Inserts

General turning

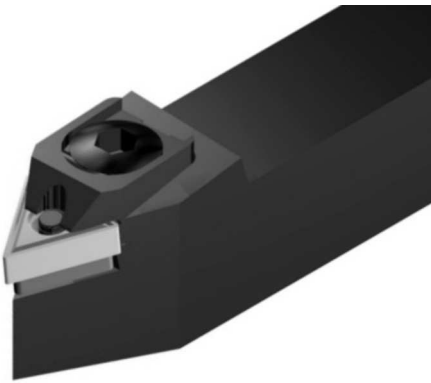

**Characteristics:**

Profiling toolholder equipped with triangular negative double side insert (angle 60°) with strong cutting edge. The clamp fixing ensures good rigidity and stability in roughing applications.

**Applications:**



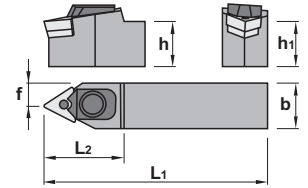
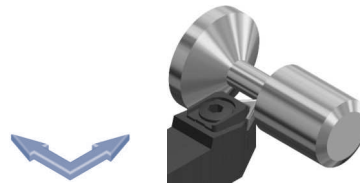

Profiling toolholder for general applications, roughing, semi-finishing and finishing.











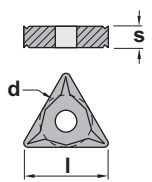

**Axial:** -8°  
**Radial:** -2.5°



# MTNN 63°

Ref.		h=h <sub>1</sub>	b	L <sub>1</sub>	L <sub>2</sub>	f	Insert size	kg
MTNN R/L 2020 K16	MTNN R/L 2020 K16	20	20	125	34	10,0	TNM.. 1604..	0,450
	MTNN R/L 2525 M16	25	25	150	34	12,5	TNM.. 1604..	0,800
	MTNN R/L 3225 P16	32	25	170	34	12,5	TNM.. 1604..	1,200
MTNN R/L 2525 M22	MTNN R/L 2525 M22	25	25	150	42	12,5	TNM.. 2204..	0,800
	MTNN R/L 3225 P22	32	25	170	42	12,5	TNM.. 2204..	1,200
	MTNN R/L 3232 P22	32	32	170	42	16,0	TNM.. 2204..	1,400
MTNN R/L 4025 R22	MTNN R/L 4025 R22	40	25	200	42	12,5	TNM.. 2204..	1,500
	MTNN R/L 5032 S22	50	32	250	45	16,0	TNM.. 2204..	2,950

Ref.						
MTNN R/L 2020 K16	MTNN R/L 2020 K16	2014	5005	3414	1642	1393
	MTNN R/L 2525 M16	2014	5005	3414	1642	1393
	MTNN R/L 3225 P16	2014	5005	3414	1642	1393
MTNN R/L 2525 M22	MTNN R/L 2525 M22	2024	5005	ITSN-433	1661	1394
	MTNN R/L 3225 P22	2024	5005	ITSN-433	1661	1394
	MTNN R/L 3232 P22	2024	5005	ITSN-433	1661	1394
MTNN R/L 4025 R22	MTNN R/L 4025 R22	2024	5005	ITSN-433	1661	1394
	MTNN R/L 5032 S22	2024	5005	ITSN-433	1661	1394

	TNM..				Negative triangular inserts.					
	Ref.	TNM.. 1604..	TNM.. 2204..	l	s	d	For more information see page: A.29			
				16,50	4,76	9,52	TNMG-CF	TNMG-CM	TNMG-CS	
										
	TNMA	TNMG-CFC	TNMG-CFM	TNMG-CMC	TNMG-CMF	TNMG-CMR	TNMX-R	TNMX-L		
										



**Characteristics:**

External turning and profiling toolholder equipped with rhombic negative double side insert (angle 35°) with strong cutting edge.

The center pin and top clamp ensure good rigidity and stability in roughing applications.

**Applications:**

External turning and profiling toolholder for general applications, roughing, semi-finishing and finishing.

For low powered machines and small pieces choose toolholder Ref. SVJC (Page: B.76).

**Axial:** -6°  
**Radial:** -6°

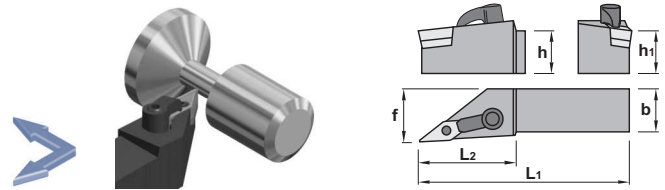

## MVJN-K 93°

Ref.		h=h <sub>1</sub>	b	L <sub>1</sub>	L <sub>2</sub>	f	Insert size	kg
MVJN R/L 2020 K16-K		20	20	125	43	25	VN.. 1604..	0,450
MVJN R/L 2525 M16-K		25	25	150	43	32	VN.. 1604..	0,800
MVJN R/L 3225 P16-K		32	25	170	43	32	VN.. 1604..	1,200

Ref.							
MVJN R/L 2020 K16-K		2616	1086	5003	IVSN-322	1665	5002
MVJN R/L 2525 M16-K		2616	1086	5003	IVSN-322	1665	5002
MVJN R/L 3225 P16-K		2616	1086	5003	IVSN-322	1665	5002

	VN..				Negative 35° rhombic inserts.
	Ref.	VN.. 1604..	l	s	
			16,50	4,76	9,52
	VNGP	VNMG	VNMG-CMC		

For more information see page: A.33

General turning  
Aluminium wheel turning  
Automatic lathes  
Ceramic tools  
Parting and grooving  
Threading  
Drills  
Cartridges  
Brazed tools  
Tooling

Inserts

General turning



**Characteristics:**

Turning and profiling toolholder equipped with rhombic negative double side insert (angle 35°) with strong cutting edge.

The center pin and top clamp ensure good rigidity and stability in roughing applications.

**Applications:**





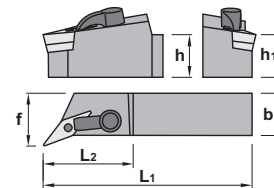
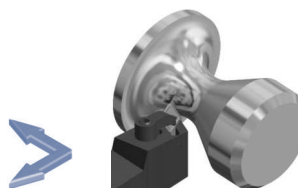

External turning and profiling toolholder for general applications, roughing, semi-finishing and finishing.



**Axial:** -8°  
**Radial:** -10°



**MVQN-K 117°30'**

Ref.		h=h <sub>1</sub>	b	L <sub>1</sub>	L <sub>2</sub>	f	Insert size	kg
MVQN R/L 2020 K16-K		20	20	125	43	25	VN.. 1604..	0,450
MVQN R/L 2525 M16-K		25	25	150	43	32	VN.. 1604..	0,800
MVQN R/L 3225 P16-K		32	25	170	43	32	VN.. 1604..	1,200

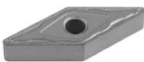
Ref.							
MVQN R/L 2020 K16-K		2616	1086	5003	IVSN-322	1665	5002
MVQN R/L 2525 M16-K		2616	1086	5003	IVSN-322	1665	5002
MVQN R/L 3225 P16-K		2616	1086	5003	IVSN-322	1665	5002

Ref.	VN..			Negative 35° rhombic inserts.
	l	s	d	
VN.. 1604..	16,50	4,76	9,52	
	VNGP	VNMG	VNMG-CMC	
				

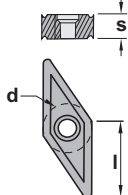

For more information see page: A.33

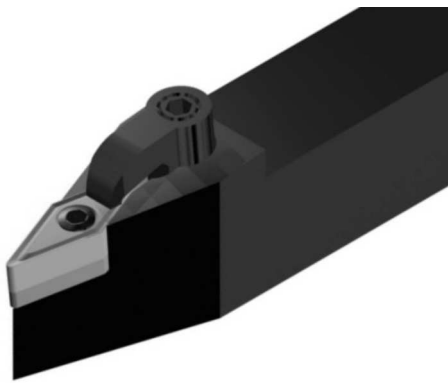

**Characteristics:**

Profiling toolholder equipped with rhombic negative double side insert (angle 35°) with strong cutting edge. The center pin and top clamp ensures good rigidity and stability in roughing applications.

**Applications:**

Profiling turning toolholder for general applications, roughing, semi-finishing and finishing.

For low powered machines and small pieces choose toolholder Ref. SVVC (Page: B.79).

**Axial:** 6°  
**Radial:** 0°

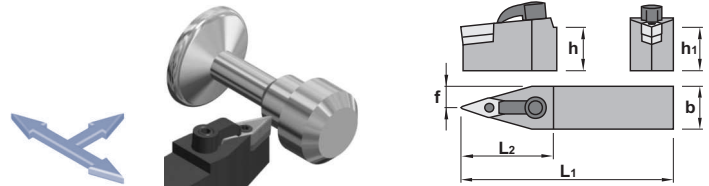

## MVVN-K 72°30'

Ref.		h=h <sub>1</sub>	b	L <sub>1</sub>	L <sub>2</sub>	f	Insert size	Kg
MVVN N 2020 K16-K		20	20	125	43	10,0	VN.. 1604..	0,450
MVVN N 2525 M16-K		25	25	150	43	12,5	VN.. 1604..	0,800

Ref.							
MVVN N 2020 K16-K		2616	1086	5003	IVSN-322	1665	5002
MVVN N 2525 M16-K		2616	1086	5003	IVSN-322	1665	5002

	VN..				Negative 35° rhombic inserts.  For more information see page: A.33	
	Ref.	VN.. 1604..	l	s		d
	VNGP	VNMG	VNMG-CMC			

General turning  
Aluminium wheel turning  
Automatic lathes  
Ceramic tools  
Parting and grooving  
Threading  
Drills  
Cartridges  
Brazed tools  
Tooling



Inserts  
General turning

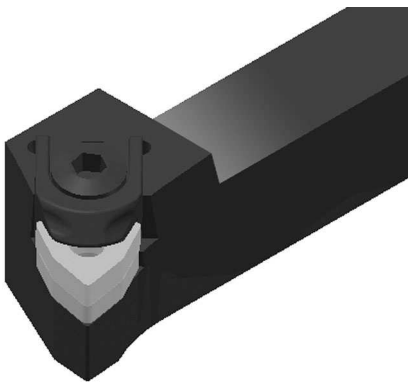

**Characteristics:**

Multipurpose toolholder equipped with trigon negative double side insert (angle 80°) with strong cutting edge. The center pin and top clamp ensure good rigidity and stability in roughing applications.

**Applications:**

External turning toolholder for general applications, roughing, semi-finishing and finishing. Not suitable for cermet, ceramic and K10, P10 grade inserts.

**Axial:** -6.5°  
**Radial:** -6.5°

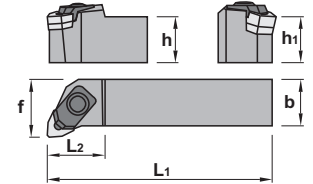
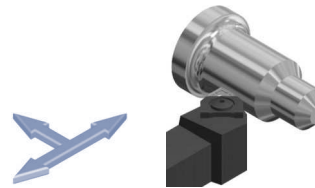

MWLN 95°		h=h <sub>1</sub>	b	L <sub>1</sub>	L <sub>2</sub>	f	Insert size	kg
Ref.	MWLN R/L 1616 H06	16	16	100	15	20	WNMG 0604..	0,200
	MWLN R/L 2020 K06	20	20	125	22	25	WNMG 0604..	0,450
	MWLN R/L 2525 M06	25	25	150	28	32	WNMG 0604..	0,800
	MWLN R/L 2020 K08	20	20	125	34	25	WNMG 0804..	0,450
	MWLN R/L 2525 M08	25	25	150	34	32	WNMG 0804..	0,800
	MWLN R/L 3225 P08	32	25	170	34	32	WNMG 0804..	1,200
	MWLN R/L 3232 P08	32	32	170	34	40	WNMG 0804..	1,400

Ref.					
MWLN R/L 1616 H06	2006	5025	3006	1644	1393
MWLN R/L 2020 K06	2006	5025	3006	1642	1393
MWLN R/L 2525 M06	2006	5025	3006	1642	1393
MWLN R/L 2020 K08	2011	5005	IWSN-433	1661	1394
MWLN R/L 2525 M08	2011	5005	IWSN-433	1661	1394
MWLN R/L 3225 P08	2011	5005	IWSN-433	1661	1394
MWLN R/L 3232 P08	2011	5005	IWSN-433	1661	1394

Ref.	WNMG				Negative 80° trigon inserts.		
	l	s	d	For more information see page: A.34			
	WNMG-CF	WNMG-CM	WNMG-CS				
WNMG 0604..	6,45	4,76	9,52				
WNMG 0804..	8,14	4,76	12,70				
	WNMG-CFM	WNMG-CMC	WNMG-CMF	WNMG-CMR			

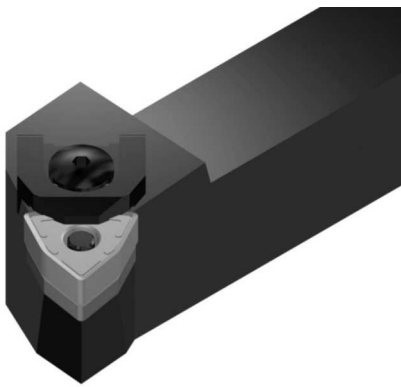

**Characteristics:**

Multipurpose toolholder equipped with trigon negative double side insert (angle 80°) with strong cutting edge. The center pin and top clamp ensure good rigidity and stability in roughing applications.

**Applications:**

External turning toolholder for general applications, roughing, semi-finishing and finishing. Specially recommended for cermet, ceramic and K10, P10 grade inserts.

**Axial:** -5.5°  
**Radial:** -6.5°

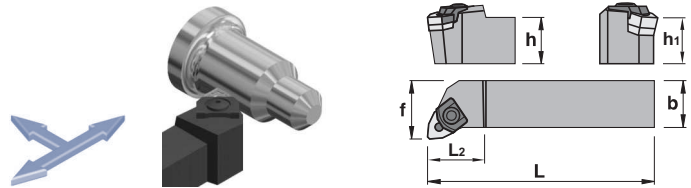

## MWLN-K 95°

Ref.		h=h <sub>1</sub>	b	L <sub>1</sub>	L <sub>2</sub>	f	Insert size	kg
MWLN R/L 2020 K08-K		20	20	125	34	25	WNM.. 0804..	0,450
MWLN R/L 2525 M08-K		25	25	150	34	32	WNM.. 0804..	0,800
MWLN R/L 3232 P08-K		32	32	170	34	40	WNM.. 0804..	1,400

Ref.						
MWLN R/L 2020 K08-K		2018	5025	IWSN-433	1661	1394
MWLN R/L 2525 M08-K		2018	5025	IWSN-433	1661	1394
MWLN R/L 3232 P08-K		2018	5025	IWSN-433	1661	1394

	WNM..				Negative 80° trigon inserts.		
	Ref.	l	s	d	For more information see page: A.34		
	WNM.. 0804..	8,14	4,76	12,70	WNUMG-CF	WNUMG-CM	WNUMG-CS
	WNMA	WNUMG-CFM	WNUMG-CMC	WNUMG-CMF	WNUMG-CMR		

General turning  
 Aluminium wheel turning  
 Automatic lathes  
 Ceramic tools  
 Parting and grooving  
 Threading  
 Drills  
 Cartridges  
 Brazed tools  
 Tooling

Inserts

General turning

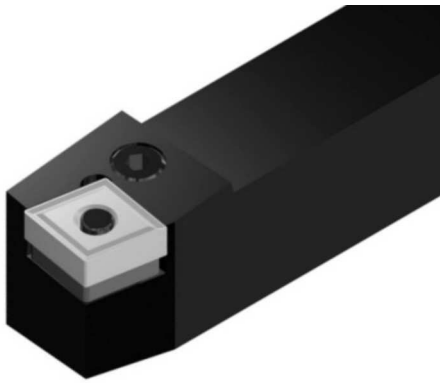

**Characteristics:**

Toolholder for external turning applications equipped with rhombic negative inserts (angle 80°) and strong cutting edges.

The lever lock ensures good rigidity and chip flow in roughing applications.

**Applications:**

External turning toolholder for general applications, roughing, semi-finishing and finishing.

**Axial:** -7.25°  
**Radial:** -4.25°

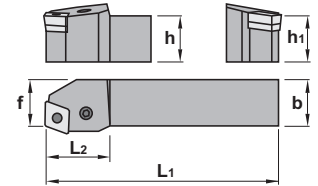
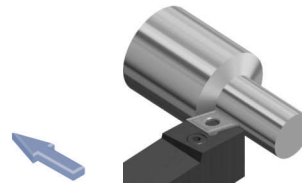

PCBN 75°		h=h <sub>1</sub>	b	L <sub>1</sub>	L <sub>2</sub>	f	Insert size	kg
Ref.	PCBN R/L 2020 K12	20	20	125	28	17	CN.. 1204..	0,400
	PCBN R/L 2525 M12	25	25	150	28	22	CN.. 1204..	0,750
	PCBN R/L 2525 M16	25	25	150	34	22	CN.. 1606..	0,750
	PCBN R/L 3225 P16	32	25	170	34	22	CN.. 1606..	1,050
	PCBN R/L 3232 P16	32	32	170	34	27	CN.. 1606..	1,300
	PCBN R/L 3225 P19	32	25	170	42	22	CN.. 1906..	1,050
	PCBN R/L 3232 P19	32	32	170	42	27	CN.. 1906..	1,300
	PCBN R/L 4040 S19	40	40	250	45	35	CN.. 1906..	3,050
	PCBN R/L 4040 S25	40	40	250	48	41	CN.. 2509..	-
	PCBN R/L 5050 T25	50	50	300	50	51	CN.. 2509..	-

Ref.	PCBN R/L 2020 K12	PCBN R/L 2525 M12	PCBN R/L 2525 M16	PCBN R/L 3225 P16	PCBN R/L 3232 P16	PCBN R/L 3225 P19	PCBN R/L 3232 P19	PCBN R/L 4040 S19	PCBN R/L 4040 S25	PCBN R/L 5050 T25
	8012	8012	8016	8016	8016	8019	8019	8019	8025	8025
	1608	1608	1618	1618	1618	1610	1610	1610	1612	1612
	5003	5003	5003	5003	5003	5004	5004	5004	5005	5005
	3612	3612	3616	3616	3616	3619	3619	3619	3625	3625
	4112	4112	4115	4115	4115	4119	4119	4119	4125	4125
	0012	0012	0015	0015	0015	0019	0019	0019	0025	0025

Ref.	CN..				Negative 80° rhombic inserts.			
	l	s	d	CNMG-CF	CNMG-CM	CNMG-CR	CNMG-CS	
CN.. 1204..	12,90	4,76	12,70					
CN.. 1606..	16,10	6,35	15,88					
CN.. 1906..	19,30	6,35	19,05					
CN.. 2509..	25,80	9,52	25,40					
	CNGP	CNMA	CNMG-CFM	CNMG-CFC	CNMG-CMC	CNMG-CMF	CNMG-CMR	CNMM

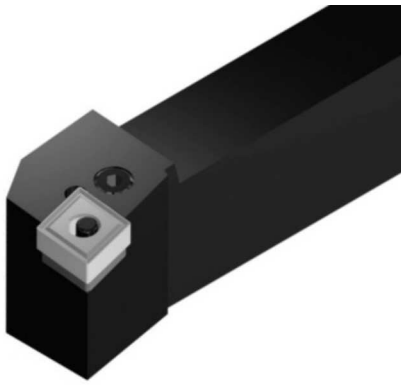

**Characteristics:**

Toolholder for face turning applications equipped with rhombic negative inserts (angle 80°) and strong cutting edges.

The lever lock ensures good rigidity and chip flow in roughing applications.

**Applications:**

Face turning toolholder for general applications, roughing, semi-finishing and finishing.

**Axial:** -6°  
**Radial:** -6°

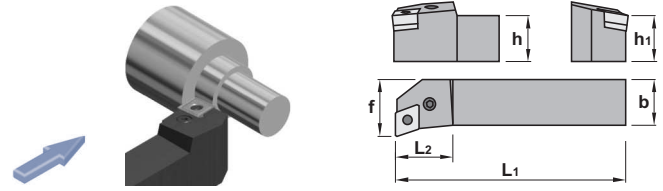

## PCFN 90°

Ref.		h=h <sub>1</sub>	b	L <sub>1</sub>	L <sub>2</sub>	f	Insert size	kg
Ref.	PCFN R/L 2525 M12	25	25	150	28	32	CN.. 1204..	0,750
	PCFN R/L 2525 M16	25	25	150	34	32	CN.. 1606..	0,750
	PCFN R/L 3225 P16	32	25	170	34	32	CN.. 1606..	1,050
	PCFN R/L 3232 P16	32	32	170	34	40	CN.. 1606..	1,300
	PCFN R/L 3225 P19	32	25	170	42	32	CN.. 1906..	1,050
	PCFN R/L 3232 P19	32	32	170	42	40	CN.. 1906..	1,300
	PCFN R/L 4040 S19	40	40	250	45	50	CN.. 1906..	3,050

Ref.	PCFN R/L 2525 M12						
	PCFN R/L 2525 M16	8016	1618	5003	3616	4115	0015
	PCFN R/L 3225 P16	8016	1618	5003	3616	4115	0015
	PCFN R/L 3232 P16	8016	1618	5003	3616	4115	0015
	PCFN R/L 3225 P19	8019	1610	5004	3619	4119	0019
	PCFN R/L 3232 P19	8019	1610	5004	3619	4119	0019
	PCFN R/L 4040 S19	8019	1610	5004	3619	4119	0019

	CN..				Negative 80° rhombic inserts.			
	Ref.	l	s	d	For more information see page: A.18			
	CN.. 1204..	12,90	4,76	12,70	CNMG-CF	CNMG-CM	CNMG-CR	CNMG-CS
	CN.. 1606..	16,10	6,35	15,88				
	CN.. 1906..	19,30	6,35	19,05				
	CNGP	CNMA	CNMG-CFM	CNMG-CFC	CNMG-CMC	CNMG-CMF	CNMG-CMR	CNMM

Inserts

General turning

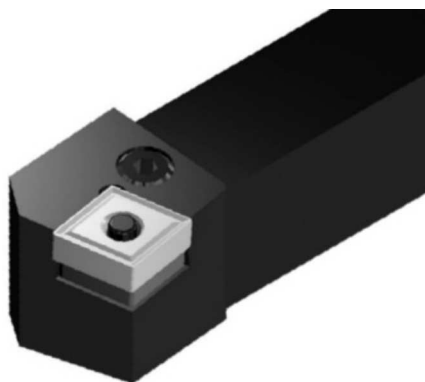

**Characteristics:**

Toolholder for face turning applications equipped with rhombic negative inserts (angle 80°) and strong cutting edges.

The lever lock ensures good rigidity and chip flow in roughing applications.

**Applications:**

Face turning toolholder for general applications, roughing, semi-finishing and finishing.

**Axial:** -6.5°  
**Radial:** -5.5°

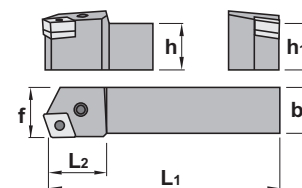
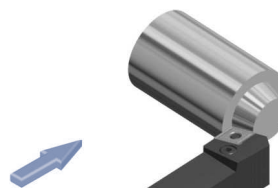

# PCKN 75°

Ref.		h=h1	b	L1	L2	f	Insert size	kg
PCKN R/L 2020 K12	PCKN R/L 2020 K12	20	20	125	28	25	CN.. 1204..	0,400
	PCKN R/L 2525 M12	25	25	150	28	32	CN.. 1204..	0,750
	PCKN R/L 3225 P12	32	25	170	28	32	CN.. 1204..	1,050
PCKN R/L 3232 P19	PCKN R/L 3232 P19	32	32	170	34	40	CN.. 1906..	1,300
	PCKN R/L 4040 S19	40	40	250	45	50	CN.. 1906..	3,050
PCKN R/L 4040 S25	PCKN R/L 4040 S25	40	40	250	45	50	CN.. 2509..	3,050
	PCKN R/L 5050 T25	50	50	300	45	60	CN.. 2509..	5,850

Ref.							
PCKN R/L 2020 K12	PCKN R/L 2020 K12	8012	1608	5003	3612	4112	0012
	PCKN R/L 2525 M12	8012	1608	5003	3612	4112	0012
	PCKN R/L 3225 P12	8012	1608	5003	3612	4112	0012
PCKN R/L 3232 P19	PCKN R/L 3232 P19	8019	1610	5004	3619	4119	0019
	PCKN R/L 4040 S19	8019	1610	5004	3619	4119	0019
PCKN R/L 4040 S25	PCKN R/L 4040 S25	8025	1612	5005	3625	4125	0025
	PCKN R/L 5050 T25	8025	1612	5005	3625	4125	0025

Ref.	CN..				Negative 80° rhombic inserts.			
	l	s	d	CNMG-CF	CNMG-CM	CNMG-CR	CNMG-CS	
CN.. 1204..	12,90	4,76	12,70					
CN.. 1906..	19,30	6,35	19,05					
CN.. 2509..	25,80	9,52	25,40					
CNGP	CNMA	CNMG-CFM	CNMG-CFC	CNMG-CMC	CNMG-CMF	CNMG-CMR	CNMM	



**Characteristics:**

Multipurpose toolholder equipped with rhombic negative double side insert (angle 80°) with strong cutting edge. The lever lock ensures good rigidity and chip flow in roughing applications.

**Applications:**

External turning toolholder for general applications, roughing, semi-finishing and finishing.

For low powered machines and small pieces choose toolholder Ref. SCLC (Page: B.61).

**Axial:** -6.5°  
**Radial:** -6.5°

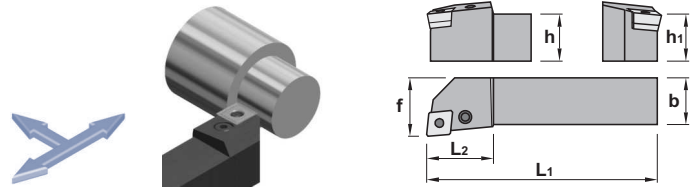

## PCLN 95°

Ref.		h=h1	b	L1	L2	f	Insert size	kg
PCLN R/L 1616 H09	PCLN R/L 1616 H09	16	16	100	25	20	CN.. 0903..	0,250
	PCLN R/L 2020 K09	20	20	125	27	25	CN.. 0903..	0,400
	PCLN R/L 2525 M09	25	25	150	27	32	CN.. 0903..	0,750
PCLN R/L 1616 H12	PCLN R/L 1616 H12	16	16	100	26	20	CN.. 1204..	0,250
	PCLN R/L 2020 K12	20	20	125	28	25	CN.. 1204..	0,400
	PCLN R/L 2525 M12	25	25	150	28	32	CN.. 1204..	0,750
	PCLN R/L 3225 P12	32	25	170	28	32	CN.. 1204..	1,050
	PCLN R/L 3232 P12	32	32	170	28	40	CN.. 1204..	1,300
PCLN R/L 2525 M16	PCLN R/L 2525 M16	25	25	150	34	32	CN.. 1606..	0,750
	PCLN R/L 3225 P16	32	25	170	34	32	CN.. 1606..	1,050
	PCLN R/L 3232 P16	32	32	170	34	40	CN.. 1606..	1,300
	PCLN R/L 4040 S16	40	40	250	34	50	CN.. 1606..	3,050
PCLN R/L 2525 M19	PCLN R/L 2525 M19	25	25	150	42	32	CN.. 1906..	0,750
	PCLN R/L 3225 P19	32	25	170	42	32	CN.. 1906..	1,050
	PCLN R/L 3232 P19	32	32	170	42	40	CN.. 1906..	1,300
	PCLN R/L 4040 S19	40	40	250	45	50	CN.. 1906..	3,050
PCLN R/L 4040 S25	PCLN R/L 4040 S25	40	40	250	45	50	CN.. 2509..	3,050
	PCLN R/L 5050 T25	50	50	300	45	60	CN.. 2509..	5,850

Ref.							
PCLN R/L 1616 H09	PCLN R/L 1616 H09	8009	1606	5025	3609	4109	0009
	PCLN R/L 2020 K09	8009	1606	5025	3609	4109	0009
	PCLN R/L 2525 M09	8009	1606	5025	3609	4109	0009
PCLN R/L 1616 H12	PCLN R/L 1616 H12	8312	1648	5003	3612	4112	0012
	PCLN R/L 2020 K12	8012	1608	5003	3612	4112	0012
	PCLN R/L 2525 M12	8012	1608	5003	3612	4112	0012
	PCLN R/L 3225 P12	8012	1608	5003	3612	4112	0012
	PCLN R/L 3232 P12	8012	1608	5003	3612	4112	0012
PCLN R/L 2525 M16	PCLN R/L 2525 M16	8016	1618	5003	3616	4115	0015
	PCLN R/L 3225 P16	8016	1618	5003	3616	4115	0015
	PCLN R/L 3232 P16	8016	1618	5003	3616	4115	0015
	PCLN R/L 4040 S16	8016	1618	5003	3616	4115	0015
PCLN R/L 2525 M19	PCLN R/L 2525 M19	8019	1610	5004	3619	4119	0019
	PCLN R/L 3225 P19	8019	1610	5004	3619	4119	0019
	PCLN R/L 3232 P19	8019	1610	5004	3619	4119	0019
	PCLN R/L 4040 S19	8019	1610	5004	3619	4119	0019
PCLN R/L 4040 S25	PCLN R/L 4040 S25	8025	1612	5005	3625	4125	0025
	PCLN R/L 5050 T25	8025	1612	5005	3625	4125	0025

Ref.	CN..				Negative 80° rhombic inserts.			
	l	s	d	CNMG-CF	CNMG-CM	CNMG-CR	CNMG-CS	
CN.. 0903..	9,65	3,18	9,52					
CN.. 1204..	12,90	4,76	12,70					
CN.. 1606..	16,10	6,35	15,88					
CN.. 1906..	19,30	6,35	19,05					
CN.. 2509..	25,80	9,52	25,40					

  

CNGP	CNMA	CNMG-CFM	CNMG-CFC	CNMG-CMC	CNMG-CMF	CNMG-CMR	CNMM

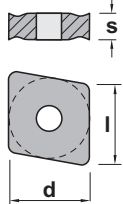

Inserts

General turning

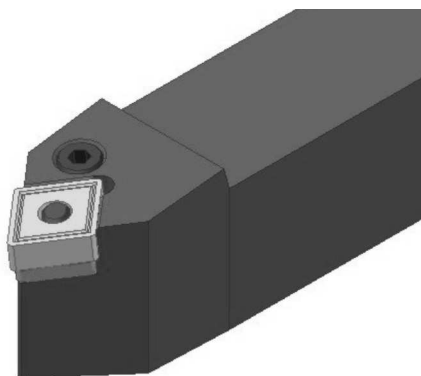

**Characteristics:**

Profiling toolholder equipped with rhombic negative double side insert (angle 80°) with strong cutting edge. The lever lock ensures good rigidity and chip flow in roughing applications.

**Applications:**

Profiling turning toolholder for general applications, roughing, semi-finishing and finishing.

**Axial:** -6°  
**Radial:** 0°

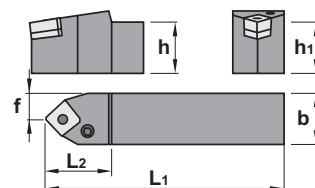
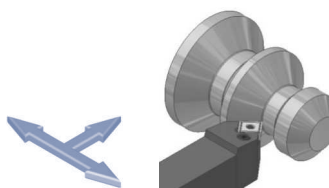

## PCMN 50°

Ref.		h=h <sub>1</sub>	b	L <sub>1</sub>	L <sub>2</sub>	f	Insert size	kg
PCMN N 2020 K12	PCMN N 2020 K12	20	20	125	34	10,0	CN.. 1204..	0,400
	PCMN N 2525 M12	25	25	150	34	12,5	CN.. 1204..	0,750
	PCMN N 3225 P12	32	25	170	34	12,5	CN.. 1204..	1,050
PCMN N 3232 P19	PCMN N 3232 P19	32	32	170	42	16,0	CN.. 1906..	1,300
	PCMN N 4040 S19	40	40	250	42	20,0	CN.. 1906..	3,050

Ref.							
PCMN N 2020 K12	PCMN N 2020 K12	8012	1608	5003	3612	4112	0012
	PCMN N 2525 M12	8012	1608	5003	3612	4112	0012
	PCMN N 3225 P12	8012	1608	5003	3612	4112	0012
PCMN N 3232 P19	PCMN N 3232 P19	8019	1610	5004	3619	4119	0019
	PCMN N 4040 S19	8019	1610	5004	3619	4119	0019

Ref.	CN..				Negative 80° rhombic inserts.			
	CN.. 1204..	l	s	d	CNMG-CF	CNMG-CM	CNMG-CR	CNMG-CS
	CN.. 1906..	12,90	4,76	12,70				
		19,30	6,35	19,05				
	CNGP	CNMA	CNMG-CFM	CNMG-CFC	CNMG-CMC	CNMG-CMF	CNMG-CMR	CNMM



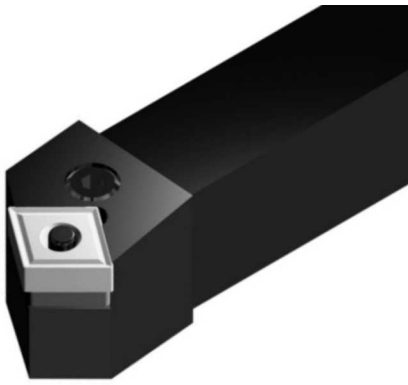

**Characteristics:**

Toolholder for external turning applications equipped with rhombic negative inserts (angle 80°) and strong cutting edges.

The lever lock ensures good rigidity and chip flow in roughing applications.

**Applications:**

External turning toolholder for general applications, roughing, semi-finishing and finishing.

**Axial:** -5.75°  
**Radial:** -5.75°

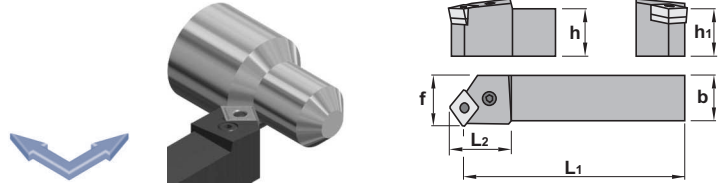

## PCSN 45°

Ref.		h=h <sub>1</sub>	b	L <sub>1</sub>	L <sub>2</sub>	f	Insert size	kg
PCSN R/L 2020 K12	PCSN R/L 2020 K12	20	20	125	28	25	CN.. 1204..	0,400
	PCSN R/L 2525 M12	25	25	150	28	32	CN.. 1204..	0,750
PCSN R/L 2525 M16	PCSN R/L 2525 M16	25	25	150	34	32	CN.. 1606..	0,750
	PCSN R/L 3225 P16	32	25	170	34	32	CN.. 1606..	1,050
	PCSN R/L 3232 P16	32	32	170	34	40	CN.. 1606..	1,300
PCSN R/L 3225 P19	PCSN R/L 3225 P19	32	25	170	42	32	CN.. 1906..	1,050
	PCSN R/L 3232 P19	32	32	170	42	40	CN.. 1906..	1,300
	PCSN R/L 4040 S19	40	40	250	45	50	CN.. 1906..	3,050

Ref.							
PCSN R/L 2020 K12	PCSN R/L 2020 K12	8012	1608	5003	3612	4112	0012
	PCSN R/L 2525 M12	8012	1608	5003	3612	4112	0012
PCSN R/L 2525 M16	PCSN R/L 2525 M16	8016	1618	5003	3616	4115	0015
	PCSN R/L 3225 P16	8016	1618	5003	3616	4115	0015
	PCSN R/L 3232 P16	8016	1618	5003	3616	4115	0015
PCSN R/L 3225 P19	PCSN R/L 3225 P19	8019	1610	5004	3619	4119	0019
	PCSN R/L 3232 P19	8019	1610	5004	3619	4119	0019
	PCSN R/L 4040 S19	8019	1610	5004	3619	4119	0019

	CN..				Negative 80° rhombic inserts.						
	Ref.	CN.. 1204..	CN.. 1606..	CN.. 1906..	l	s	d	For more information see page: A.18			
								CNMG-CF	CNMG-CM	CNMG-CR	CNMG-CS
	CNGP	CNMA	CNMG-CFM	CNMG-CFC	CNMG-CMC	CNMG-CMF	CNMG-CMR	CNMM			

Inserts

General turning



**Characteristics:**

Turning and profiling toolholder equipped with rhombic negative double side insert (angle 55°) with strong cutting edge.

The lever lock ensures good rigidity and chip flow in roughing applications.

**Applications:**

External turning toolholder for general applications, roughing, semi-finishing and finishing.

For low powered machines and small pieces choose toolholder Ref. SDJC (Page: B.62).

**Axial:** 6.25°  
**Radial:** -6.75°

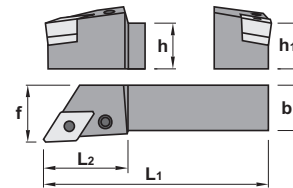
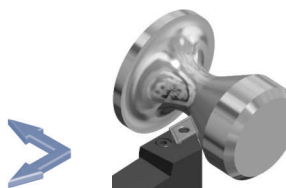

PDJN 93°		h=h <sub>1</sub>	b	L <sub>1</sub>	L <sub>2</sub>	f	Insert size	kg
Ref.	PDJN R/L 1616 H11	16	16	100	28	20	DN.. 1104..	0,250
	PDJN R/L 2020 K11	20	20	125	28	25	DN.. 1104..	0,400
	PDJN R/L 2525 M11	25	25	150	28	32	DN.. 1104..	0,750
	PDJN R/L 3225 P11	32	25	170	28	32	DN.. 1104..	1,050
	PDJN R/L 2020 K15	20	20	125	34	25	DN.. 1506..	0,400
	PDJN R/L 2525 M15	25	25	150	34	32	DN.. 1506..	0,750
	PDJN R/L 3225 P15	32	25	170	34	32	DN.. 1506..	1,050
	PDJN R/L 3232 P15	32	32	170	34	40	DN.. 1506..	1,300
	PDJN R/L 4025 R15	40	25	200	34	32	DN.. 1506..	1,850
	PDJN R/L 5032 S15	50	32	250	34	40	DN.. 1506..	2,900

Ref.	PDJN R/L 1616 H11	PDJN R/L 2020 K11	PDJN R/L 2525 M11	PDJN R/L 3225 P11	PDJN R/L 2020 K15	PDJN R/L 2525 M15	PDJN R/L 3225 P15	PDJN R/L 3232 P15	PDJN R/L 4025 R15	PDJN R/L 5032 S15		
	8009	8009	8009	8009	8415	8415	8415	8415	8415	8415		
	1606	1606	1606	1606	1638	1638	1638	1638	1638	1638		
	5025	5025	5025	5025	5003	5003	5003	5003	5003	5003		
	3711	3711	3711	3711	3715	3715	3715	3715	3715	3715		
	4109	4109	4109	4109	4112	4112	4112	4112	4112	4112		
	0009	0009	0009	0009	0012	0012	0012	0012	0012	0012		
	-	-	-	-	3725	3725	3725	3725	3725	3725		
	-	-	-	-	4135	4135	4135	4135	4135	4135		

For inserts DNM.. 1504

Ref.	DN..				Negative 55° rhombic inserts.							
	DN.. 1104..	DN.. 1504..	DN.. 1506..		DNMG-CF	DNMG-CM	DNMG-CS					
	11,60	15,50	15,50									
	4,76	4,76	6,35									
	9,52	12,70	12,70									

For more information see page: A.22

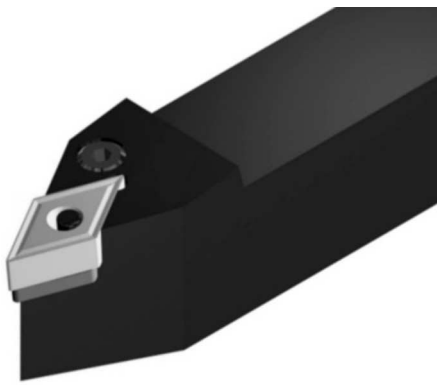

**Characteristics:**

Profiling toolholder equipped with rhombic negative double side insert (angle 55°) with strong cutting edge. The lever lock ensures good rigidity and chip flow in roughing applications.

**Applications:**

Profiling turning toolholder for general applications, roughing, semi-finishing and finishing.

For low powered machines and small pieces choose toolholder Ref. SDNC (Page: B.63).

**Axial:** -8°  
**Radial:** -2.5°

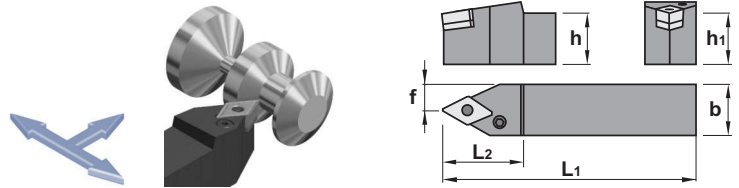

## PDNN 63°

Ref.		h=h <sub>1</sub>	b	L <sub>1</sub>	L <sub>2</sub>	f	Insert size	kg
PDNN R/L/N 2020 K15		20	20	125	34	10,0	DN.. 1506..	0,400
PDNN R/L/N 2525 M15		25	25	150	34	12,5	DN.. 1506..	0,750
PDNN R/L/N 3225 P15		32	25	170	34	12,5	DN.. 1506..	1,050
PDNN R/L/N 3232 P15		32	32	170	34	16,0	DN.. 1506..	1,300
PDNN R/L/N 4025 S15		40	25	250	34	12,5	DN.. 1506..	1,850
PDNN R/L/N 5032 S15		50	32	250	34	16,0	DN.. 1506..	2,900

Ref.									
PDNN R/L/N 2020 K15		8415	1638	5003	3715	4112	0012	3725	4135
PDNN R/L/N 2525 M15		8415	1638	5003	3715	4112	0012	3725	4135
PDNN R/L/N 3225 P15		8415	1638	5003	3715	4112	0012	3725	4135
PDNN R/L/N 3232 P15		8415	1638	5003	3715	4112	0012	3725	4135
PDNN R/L/N 4025 S15		8415	1638	5003	3715	4112	0012	3725	4135
PDNN R/L/N 5032 S15		8415	1638	5003	3715	4112	0012	3725	4135

For inserts DNM.. 1504

Ref.	DN..				Negative 55° rhombic inserts.			For more information see page: A.22
	l	s	d	DNMG-CF	DNMG-CM	DNMG-CS		
DN.. 1504..	15,50	4,76	12,70					
DN.. 1506..	15,50	6,35	12,70					
	DNGP	DNMA	DNMG-CFC	DNMG-CFM	DNMG-CMC	DNMG-CMF	DNMG-CMR	DNMX

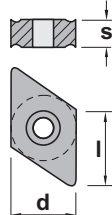

Inserts

General turning

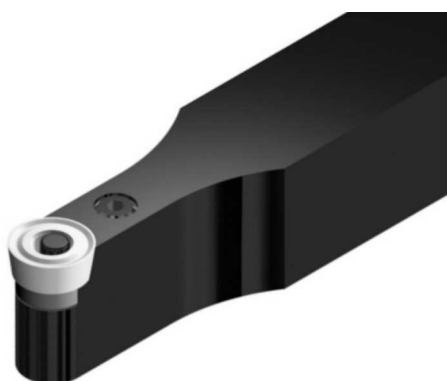

**Characteristics:**

Profiling toolholder equipped with round positive insert with strong cutting edge. The lever lock ensures good rigidity and chip flow in roughing applications.

**Applications:**

Profiling turning toolholder for general applications, roughing, semi-finishing and finishing.

For screw type toolholders Ref. SRDCN (Page: B.64).

**Axial:** 0°  
**Radial:** 0°

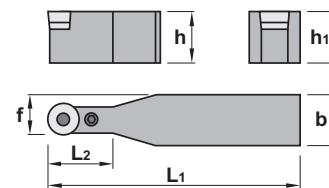
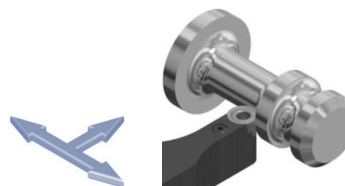

**PRDC**

	h=h <sub>1</sub>	b	L <sub>1</sub>	L <sub>2</sub>	f	Insert size	kg
PRDC N 2020 K10	20	20	125	22	15,0	RC.. 1003M0	0,400
PRDC N 2525 M10	25	25	150	22	18,5	RC.. 1003M0	0,750
PRDC N 3225 P10	32	25	170	22	18,5	RC.. 1003M0	1,050
PRDC N 2020 K12	20	20	125	28	16,0	RC.. 1204M0	0,400
PRDC N 2525 M12	25	25	150	28	18,5	RC.. 1204M0	0,750
PRDC N 3225 P12	32	25	170	28	18,5	RC.. 1204M0	1,050
PRDC N 4025 S12	40	25	250	28	18,5	RC.. 1204M0	1,850
PRDC N 3225 P16	32	25	170	34	20,5	RC.. 1606M0	1,050
PRDC N 3232 P16	32	32	170	34	24,0	RC.. 1606M0	1,300
PRDC N 3232 P20	32	32	170	42	26,0	RC.. 2006M0	1,300
PRDC N 4040 S20	40	40	250	42	30,0	RC.. 2006M0	3,050
PRDC N 4040 S25	40	40	250	45	32,5	RC.. 2507M0	3,050
PRDC N 4040 U25	40	40	350	45	32,5	RC.. 2507M0	3,050
PRDC N 5050 U25	50	50	350	45	37,5	RC.. 2507M0	5,850
PRDC N 5050 V32	50	50	400	52	41,0	RC.. 3209M0	5,850

PRDC N 2020 K10	8110	1705	5002	3810	4110	0009
PRDC N 2525 M10	8110	1705	5002	3810	4110	0009
PRDC N 3225 P10	8110	1705	5002	3810	4110	0009
PRDC N 2020 K12	8112	1606	5025	3812	4110	0009
PRDC N 2525 M12	8112	1606	5025	3812	4110	0009
PRDC N 3225 P12	8112	1606	5025	3812	4110	0009
PRDC N 4025 S12	8112	1606	5025	3812	4110	0009
PRDC N 3225 P16	8116	1706	5025	3816	4116	0012
PRDC N 3232 P16	8116	1706	5025	3816	4116	0012
PRDC N 3232 P20	8120	1708	5003	3820	4115	0015
PRDC N 4040 S20	8120	1708	5003	3820	4115	0015
PRDC N 4040 S25	8125	1710	5004	3825	4119	0019
PRDC N 4040 U25	8125	1710	5004	3825	4119	0019
PRDC N 5050 U25	8125	1710	5004	3825	4119	0019
PRDC N 5050 V32	8132	1612	5005	3832	4125	0025

Ref.	RC..	s	d	Positive 7° clearance - Round inserts.
	RC.. 1003M0	3,18	10,00	
RC.. 1204M0	4,76	12,00		
RC.. 1606M0	6,35	16,00		
RC.. 2006M0	6,35	20,00		
RC.. 2507M0	7,94	25,00		
RC.. 3209M0	9,52	32,00		

RCGT-AL	RCGT-AP	RCMT

For more information see page: A.25

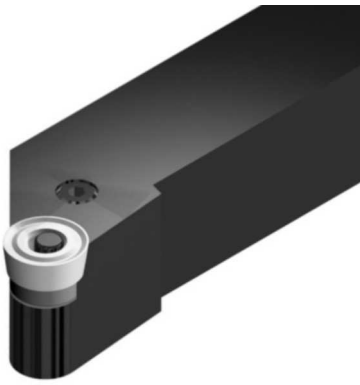

**Characteristics:**

Profiling multipurpose turning toolholder equipped with round positive insert with strong cutting edge. The lever lock ensures good rigidity and chip flow in roughing applications.

**Applications:**

Profiling multipurpose turning toolholder for general applications, roughing, semi-finishing and finishing.

**Axial:** 0°  
**Radial:** 0°

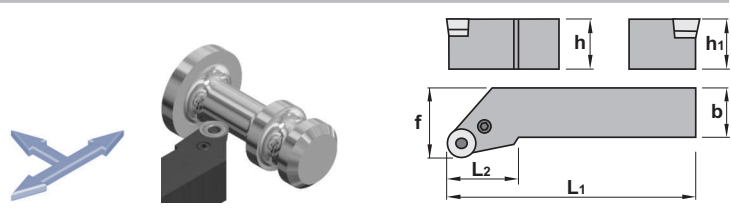

# PRSC

Ref.		h=h1	b	L1	L2	f	Insert size	kg
PRSC R/L	2020 K10	20	20	125	28	25	RC.. 1003M0	0,400
	2525 M10	25	25	150	28	32	RC.. 1003M0	0,750
	3225 P10	32	25	170	28	32	RC.. 1003M0	1,050
	2020 K12	20	20	125	28	25	RC.. 1204M0	0,400
	2525 M12	25	25	150	28	32	RC.. 1204M0	0,750
	3225 P12	32	25	170	28	32	RC.. 1204M0	1,050
	2525 M16	25	25	150	34	32	RC.. 1606M0	0,750
	3225 P16	32	25	170	34	32	RC.. 1606M0	1,050
	3232 P20	32	32	170	42	40	RC.. 2006M0	1,300
	4040 S20	40	40	250	42	50	RC.. 2006M0	3,050
PRSC R/L	4040 S25	40	40	250	45	50	RC.. 2507M0	3,050
	5050 T32	50	50	300	45	63	RC.. 3209M0	5,850

Ref.							
PRSC R/L	2020 K10	8110	1705	5002	3810	4110	0009
	2525 M10	8110	1705	5002	3810	4110	0009
	3225 P10	8110	1705	5002	3810	4110	0009
PRSC R/L	2020 K12	8112	1606	5025	3812	4110	0009
	2525 M12	8112	1606	5025	3812	4110	0009
	3225 P12	8112	1606	5025	3812	4110	0009
PRSC R/L	2525 M16	8116	1706	5025	3816	4116	0012
	3225 P16	8116	1706	5025	3816	4116	0012
PRSC R/L	3232 P20	8120	1708	5003	3820	4115	0015
	4040 S20	8120	1708	5003	3820	4115	0015
PRSC R/L	4040 S25	8125	1710	5004	3825	4119	0019
	5050 T32	8132	1612	5005	3832	4125	0025

Ref.	RC..	s	d	Positive 7° clearance - Round inserts.		
	RC.. 1003M0	3,18	10,00			
RC.. 1204M0	4,76	12,00				
RC.. 1606M0	6,35	16,00				
RC.. 2006M0	6,35	20,00				
RC.. 2507M0	7,94	25,00				
RC.. 3209M0	9,52	32,00				

For more information see page: A.25			
	RCGT-AL	RCGT-AP	RCMT

General turning

Aluminium wheel turning

Automatic lathes

Ceramic tools

Parting and grooving

Threading

Drills

Cartridges

Brazed tools

Tooling

Inserts

General turning



**Characteristics:**

Profiling multipurpose turning toolholder equipped with round negative insert with strong cutting edge. The lever lock ensures good rigidity and chip flow in roughing applications.

**Applications:**

Profiling multipurpose turning toolholder for general applications, roughing, semi-finishing and finishing.

**Axial:** -6°  
**Radial:** -6°

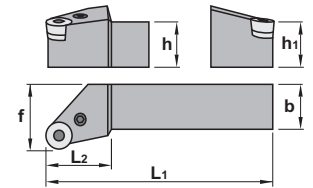
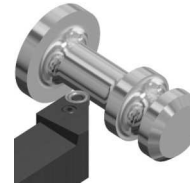

PRSN		h=h <sub>1</sub>	b	L <sub>1</sub>	L <sub>2</sub>	f	Insert size	kg
Ref.	<b>PRSN R/L 2020 K09</b>	20	20	125	22	25	RNMG 090300	0,400
	<b>PRSN R/L 2525 M12</b>	25	25	150	28	32	RNMG 120400	0,750
	<b>PRSN R/L 3225 P15</b>	32	25	170	34	32	RNMG 150600	1,050
	<b>PRSN R/L 3232 P19</b>	32	32	170	42	40	RNMG 190600	1,300
	<b>PRSN R/L 4040 S25</b>	40	40	250	45	50	RNMG 250900	3,050

Ref.	PRSN R/L 2020 K09	PRSN R/L 2525 M12	PRSN R/L 3225 P15	PRSN R/L 3232 P19	PRSN R/L 4040 S25
	8009	8012	8015	8019	8025
	1606	1608	1708	1610	1612
	5025	5003	5003	5004	5005
	3909	3912	3915	3919	3925
	4110	4112	4115	4119	4125
	0009	0012	0015	0019	0025

Ref.	RNMG		Negative round inserts.
	s	d	
	RNMG 090300	3,18	9,52
	RNMG 120400	4,76	12,70
	RNMG 150600	6,35	15,88
	RNMG 190600	6,35	19,05
	RNMG 250900	9,52	25,40

For more information see page: A.26

RNMG		

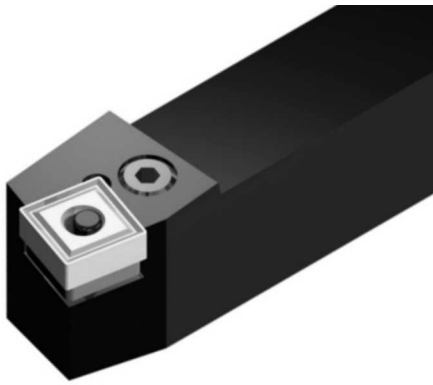

**Characteristics:**

Toolholder for external turning applications equipped with square negative inserts and strong cutting edges. The lever lock ensures good rigidity and chip flow in roughing applications.

**Applications:**

External turning toolholder for general applications, roughing, semi-finishing and finishing.

For low powered machines and small pieces choose toolholder Ref. CSBP (Page: B.08) or SSBC (Page: B.65).

**Axial:** -7.25°  
**Radial:** -4.25°

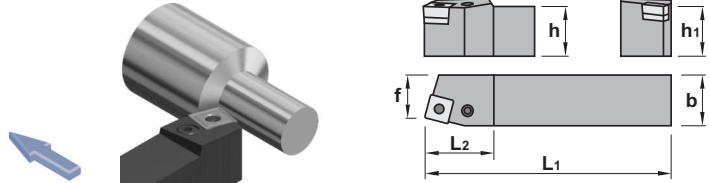

# PSBN 75°

Ref.		h=h1	b	L1	L2	f	Insert size	⚖️
PSBN R/L 1212 F09	PSBN R/L 1212 F09	12	12	80	18	11	SNM.. 0903..	0,100
	PSBN R/L 1616 H09	16	16	100	22	13	SNM.. 0903..	0,250
	PSBN R/L 2020 K09	20	20	125	22	17	SNM.. 0903..	0,400
PSBN R/L 2020 K12	PSBN R/L 2020 K12	20	20	125	28	17	SNM.. 1204..	0,400
	PSBN R/L 2525 M12	25	25	150	28	22	SNM.. 1204..	0,750
	PSBN R/L 3225 P12	32	25	170	28	22	SNM.. 1204..	1,050
PSBN R/L 2525 M15	PSBN R/L 2525 M15	25	25	150	34	22	SNM.. 1506..	0,750
	PSBN R/L 3232 P15	32	32	170	34	27	SNM.. 1506..	1,300
PSBN R/L 3232 P19	PSBN R/L 3232 P19	32	32	170	42	27	SNM.. 1906..	1,300
	PSBN R/L 4040 S19	40	40	250	45	35	SNM.. 1906..	3,050
PSBN R/L 4040 S25	PSBN R/L 4040 S25	40	40	250	45	35	SNM.. 2507..	3,050
	PSBN R/L 5050 T25	50	50	300	45	43	SNM.. 2507..	5,850

Ref.							
PSBN R/L 1212 F09	PSBN R/L 1212 F09	8005	1715	5002	-	-	-
	PSBN R/L 1616 H09	8009	1606	5025	3509	4110	0009
	PSBN R/L 2020 K09	8009	1606	5025	3509	4110	0009
PSBN R/L 2020 K12	PSBN R/L 2020 K12	8012	1608	5003	3512	4112	0012
	PSBN R/L 2525 M12	8012	1608	5003	3512	4112	0012
	PSBN R/L 3225 P12	8012	1608	5003	3512	4112	0012
PSBN R/L 2525 M15	PSBN R/L 2525 M15	8016	1618	5003	3515	4115	0015
	PSBN R/L 3232 P15	8016	1618	5003	3515	4115	0015
PSBN R/L 3232 P19	PSBN R/L 3232 P19	8019	1610	5004	3519	4119	0019
	PSBN R/L 4040 S19	8019	1610	5004	3519	4119	0019
PSBN R/L 4040 S25	PSBN R/L 4040 S25	8025	1612	5005	3525	4125	0025
	PSBN R/L 5050 T25	8025	1612	5005	3525	4125	0025

Ref.	SNM..				Negative square inserts.			
	l	s	d					
SNM.. 0903..	9,52	3,18	9,52					
SNM.. 1204..	12,70	4,76	12,70					
SNM.. 1506..	15,88	6,35	15,88					
SNM.. 1906..	19,05	6,35	19,05					
SNM.. 2507..	25,40	7,94	25,40					
	SNMA	SNMG-CFM	SNMG-CMR	SNMM				

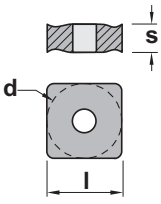



Inserts

General turning

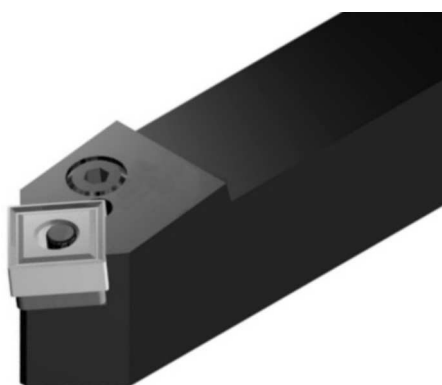

**Characteristics:**

Toolholder for external turning and chamfering applications equipped with square negative inserts and strong cutting edges. The lever lock ensures good rigidity and chip flow in roughing applications.

**Applications:**

External turning and chamfering toolholder for general applications, roughing, semi-finishing and finishing.





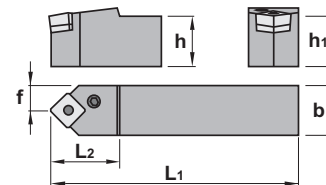
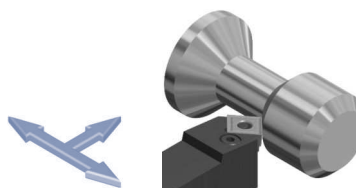

For low powered machines and small pieces choose toolholder Ref. CSDP (Page: B.09) or SSSC (Page: B.67).





**Axial:** -7°  
**Radial:** 0°



# PSDN 45°

Ref.		h=h <sub>1</sub>	b	L <sub>1</sub>	L <sub>2</sub>	f	Insert size	kg
PSDN N 1010 E09	PSDN N 1010 E09	10	10	70	16	5,0	SNM.. 0903..	0,070
	PSDN N 1212 F09	12	12	80	18	6,0	SNM.. 0903..	0,100
	PSDN N 1616 H09	16	16	100	22	8,0	SNM.. 0903..	0,250
PSDN N 2020 K12	PSDN N 2020 K12	20	20	125	28	10,0	SNM.. 1204..	0,400
	PSDN N 2525 M12	25	25	150	28	12,5	SNM.. 1204..	0,750
	PSDN N 3225 P12	32	25	170	28	12,5	SNM.. 1204..	1,050
	PSDN N 3232 P12	32	32	170	28	16,0	SNM.. 1204..	1,300
	PSDN N 3225 P19	32	25	170	42	12,5	SNM.. 1906..	1,050
PSDN N 3232 P19	32	32	170	42	16,0	SNM.. 1906..	1,300	
PSDN N 4040 S25	PSDN N 4040 S25	40	40	250	45	20,0	SNM.. 2507..	3,050
	PSDN N 5050 T25	50	50	300	45	25,0	SNM.. 2507..	5,850

Ref.							
PSDN N 1010 E09	PSDN N 1010 E09	8005	1715	5002	-	-	-
	PSDN N 1212 F09	8005	1715	5002	-	-	-
	PSDN N 1616 H09	8009	1606	5025	3509	4110	0009
PSDN N 2020 K12	PSDN N 2020 K12	8012	1608	5003	3512	4112	0012
	PSDN N 2525 M12	8012	1608	5003	3512	4112	0012
	PSDN N 3225 P12	8012	1608	5003	3512	4112	0012
	PSDN N 3232 P12	8012	1608	5003	3512	4112	0012
PSDN N 3225 P19	PSDN N 3225 P19	8019	1610	5004	3519	4119	0019
	PSDN N 3232 P19	8019	1610	5004	3519	4119	0019
PSDN N 4040 S25	PSDN N 4040 S25	8025	1612	5005	3525	4125	0025
	PSDN N 5050 T25	8025	1612	5005	3525	4125	0025

Ref.	SNM..				Negative square inserts.			
	l	s	d	SNMG-CR				
SNM.. 0903..	9,52	3,18	9,52					
SNM.. 1204..	12,70	4,76	12,70					
SNM.. 1906..	19,05	6,35	19,05					
SNM.. 2507..	25,40	7,94	25,40					
	SNMA	SNMG-CFM	SNMG-CMR	SNMM				
								



**Characteristics:**

Toolholder for face turning applications equipped with square negative inserts and strong cutting edges. The lever lock ensures good rigidity and chip flow in roughing applications.

**Applications:**

Face turning toolholder for general applications, roughing, semi-finishing and finishing.

For low powered machines and small pieces choose toolholder Ref. CSKP (Page: B.10).

**Axial:** -4.25°  
**Radial:** -7.25°

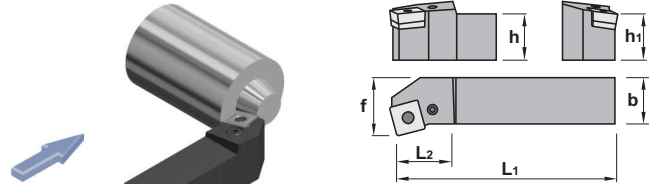

# PSKN 75°

Ref.		h=h <sub>1</sub>	b	L <sub>1</sub>	L <sub>2</sub>	f	Insert size	⚖️ Kg
PSKN R/L 1616 H09	PSKN R/L 1616 H09	16	16	100	22	20	SNM.. 0903..	0,250
	PSKN R/L 2020 K09	20	20	125	22	25	SNM.. 0903..	0,400
PSKN R/L 2020 K12	PSKN R/L 2020 K12	20	20	125	28	25	SNM.. 1204..	0,400
	PSKN R/L 2525 M12	25	25	150	28	32	SNM.. 1204..	0,750
	PSKN R/L 3225 P12	32	25	170	28	32	SNM.. 1204..	1,050
PSKN R/L 2525 M15	PSKN R/L 2525 M15	25	25	150	34	32	SNM.. 1506..	0,750
	PSKN R/L 3232 P15	32	32	170	34	40	SNM.. 1506..	1,300
PSKN R/L 3232 P19	PSKN R/L 3232 P19	32	32	170	42	40	SNM.. 1906..	1,300
	PSKN R/L 4040 S19	40	40	250	45	50	SNM.. 1906..	3,050
PSKN R/L 4040 S25	PSKN R/L 4040 S25	40	40	250	45	50	SNM.. 2507..	3,050
	PSKN R/L 5050 T25	50	50	300	45	60	SNM.. 2507..	5,850

Ref.							
PSKN R/L 1616 H09	PSKN R/L 1616 H09	8009	1606	5025	3509	4110	0009
	PSKN R/L 2020 K09	8009	1606	5025	3509	4110	0009
PSKN R/L 2020 K12	PSKN R/L 2020 K12	8012	1608	5003	3512	4112	0012
	PSKN R/L 2525 M12	8012	1608	5003	3512	4112	0012
	PSKN R/L 3225 P12	8012	1608	5003	3512	4112	0012
PSKN R/L 2525 M15	PSKN R/L 2525 M15	8016	1618	5003	3515	4115	0015
	PSKN R/L 3232 P15	8016	1618	5003	3515	4115	0015
PSKN R/L 3232 P19	PSKN R/L 3232 P19	8019	1610	5004	3519	4119	0019
	PSKN R/L 4040 S19	8019	1610	5004	3519	4119	0019
PSKN R/L 4040 S25	PSKN R/L 4040 S25	8025	1612	5005	3525	4125	0025
	PSKN R/L 5050 T25	8025	1612	5005	3525	4125	0025

Ref.	SNM..				Negative square inserts.				
	SNMA	SNMG-CFM	SNMG-CMR	SNMM	For more information see page: A.27				

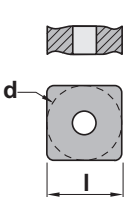

Inserts

General turning



**Characteristics:**

Toolholder for external turning and chamfering applications equipped with square negative inserts and strong cutting edges.

The lever lock ensures good rigidity and chip flow in roughing applications.

**Applications:**

External turning and chamfering toolholder for general applications, roughing, semi-finishing and finishing.

For low powered machines and small pieces choose toolholder Ref. CSSP (Page: B.11) or SSSC (Page: B.67).

**Axial:** -5.75°  
**Radial:** -5.75°

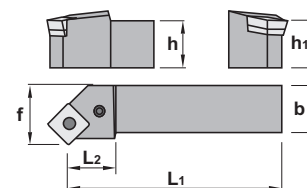
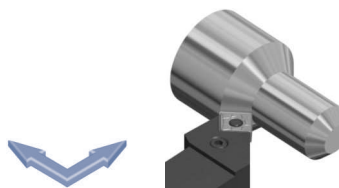

PSSN 45°		h=h1	b	L1	L2	f	Insert size	kg
Ref.	PSSN R/L 1616 H09	16	16	100	22	20	SNM.. 0903..	0,250
	PSSN R/L 2020 K09	20	20	125	22	25	SNM.. 0903..	0,400
	PSSN R/L 2020 K12	20	20	125	28	25	SNM.. 1204..	0,400
	PSSN R/L 2525 M12	25	25	150	28	32	SNM.. 1204..	0,750
	PSSN R/L 3225 P12	32	25	170	28	32	SNM.. 1204..	1,050
	PSSN R/L 2525 M15	25	25	150	34	32	SNM.. 1506..	0,750
	PSSN R/L 3232 P15	32	32	170	34	40	SNM.. 1506..	1,300
	PSSN R/L 3232 P19	32	32	170	42	40	SNM.. 1906..	1,300
	PSSN R/L 4040 S19	40	40	250	45	50	SNM.. 1906..	3,050
	PSSN R/L 5050 T19	50	50	300	45	60	SNM.. 1906..	5,850
	PSSN R/L 4040 S25	40	40	250	45	50	SNM.. 2507..	3,050
	PSSN R/L 5050 T25	50	50	300	45	60	SNM.. 2507..	5,850

Ref.							
Ref.	PSSN R/L 1616 H09	8009	1606	5025	3509	4110	0009
	PSSN R/L 2020 K09	8009	1606	5025	3509	4110	0009
	PSSN R/L 2020 K12	8012	1608	5003	3512	4112	0012
	PSSN R/L 2525 M12	8012	1608	5003	3512	4112	0012
	PSSN R/L 3225 P12	8012	1608	5003	3512	4112	0012
	PSSN R/L 2525 M15	8016	1618	5003	3515	4115	0015
	PSSN R/L 3232 P15	8016	1618	5003	3515	4115	0015
	PSSN R/L 3232 P19	8019	1610	5004	3519	4119	0019
	PSSN R/L 4040 S19	8019	1610	5004	3519	4119	0019
	PSSN R/L 5050 T19	8019	1610	5004	3519	4119	0019
	PSSN R/L 4040 S25	8025	1612	5005	3525	4125	0025
	PSSN R/L 5050 T25	8025	1612	5005	3525	4125	0025

Ref.	SNM..	l	s	d	Negative square inserts.			
	Ref.	SNM.. 0903..	9,52	3,18	9,52	SNMG-CR		
	SNM.. 1204..	12,70	4,76	12,70				
	SNM.. 1506..	15,88	6,35	15,88				
	SNM.. 1906..	19,05	6,35	19,05				
	SNM.. 2507..	25,40	7,94	25,40				
	SNMA	SNMG-CFM	SNMG-CMR	SNMM				



**Characteristics:**

Toolholder for external turning and chamfering applications equipped with triangular negative inserts and strong cutting edges.

The lever lock ensures good rigidity and chip flow in roughing applications.

**Applications:**

External turning and chamfering toolholder for general applications, roughing, semi-finishing and finishing.

For low powered machines and small pieces choose toolholder Ref. CTDP (Page: B.16).

**Axial:** -5°  
**Radial:** -5°

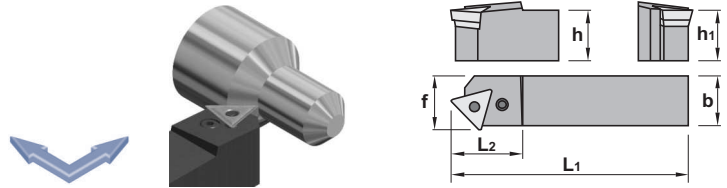

## PTDN 45°

Ref.		h=h <sub>1</sub>	b	L <sub>1</sub>	L <sub>2</sub>	f	Insert size	kg
PTDN R/L 2525 M22		25	25	150	34	27	TNM.. 2204..	0,750
	PTDN R/L 3225 P22	32	25	170	34	27	TNM.. 2204..	1,050

Ref.							
PTDN R/L 2525 M22		8012	1608	5003	3422	4112	0012
	PTDN R/L 3225 P22	8012	1608	5003	3422	4112	0012

	TNM..				Negative triangular inserts.				
	Ref.	TNM.. 2204..	l	s	d	For more information see page: A.29			
			22,00	4,76	12,70	TNMG-CM			
	TNMA	TNMG-CFM	TNMG-CMF	TNMG-CMR					

Inserts

General turning



**Characteristics:**

Toolholder for face turning applications equipped with triangular negative inserts and strong cutting edges. The lever lock ensures good rigidity and chip flow in roughing applications.

**Applications:**

Face turning toolholder for general applications, roughing, semi-finishing and finishing.

For low powered machines and small pieces choose toolholder Ref. CTFP (Page: B.17) or STFC (Page: B.69).

**Axial:** -6°  
**Radial:** -6°

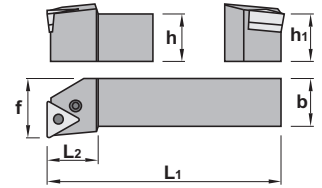
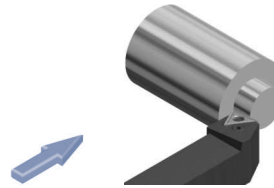

# PTFN 90°

Ref.		h=h <sub>1</sub>	b	L <sub>1</sub>	L <sub>2</sub>	f	Insert size	kg
PTFN R/L 1616 H16	PTFN R/L 1616 H16	16	16	100	22	20	TNM.. 1604..	0,250
	PTFN R/L 2020 K16	20	20	125	22	25	TNM.. 1604..	0,400
	PTFN R/L 2525 M16	25	25	150	22	32	TNM.. 1604..	0,750
	PTFN R/L 3225 P16	32	25	170	22	32	TNM.. 1604..	1,050
PTFN R/L 2525 M22	PTFN R/L 2525 M22	25	25	150	28	32	TNM.. 2204..	0,750
	PTFN R/L 3225 P22	32	25	170	28	32	TNM.. 2204..	1,050
	PTFN R/L 3232 P22	32	32	170	28	40	TNM.. 2204..	1,300
PTFN R/L 3232 P27	PTFN R/L 3232 P27	32	32	170	42	40	TNM.. 2706..	1,300
	PTFN R/L 4040 S27	40	40	250	45	50	TNM.. 2706..	3,050

Ref.							
PTFN R/L 1616 H16	PTFN R/L 1616 H16	8009	1606	5025	3416	4109	0009
	PTFN R/L 2020 K16	8009	1606	5025	3416	4109	0009
	PTFN R/L 2525 M16	8009	1606	5025	3416	4109	0009
	PTFN R/L 3225 P16	8009	1606	5025	3416	4109	0009
PTFN R/L 2525 M22	PTFN R/L 2525 M22	8012	1608	5003	3422	4112	0012
	PTFN R/L 3225 P22	8012	1608	5003	3422	4112	0012
	PTFN R/L 3232 P22	8012	1608	5003	3422	4112	0012
PTFN R/L 3232 P27	PTFN R/L 3232 P27	8015	1708	5003	3427	4115	0015
	PTFN R/L 4040 S27	8015	1708	5003	3427	4115	0015

Ref.	TNM..				Negative triangular inserts.			
	TNM.. 1604..	TNM.. 2204..	TNM.. 2706..		TNMG-CF	TNMG-CM	TNMG-CS	
	16,50	22,00	27,50	l				
	4,76	4,76	6,35	s				
	9,52	12,70	15,88	d				



**Characteristics:**

Toolholder for external turning applications equipped with triangular negative inserts and strong cutting edges. The lever lock ensures good rigidity and chip flow in roughing applications.

**Applications:**

External turning toolholder for general applications, roughing, semi-finishing and finishing.

For low powered machines and small pieces choose toolholder Ref. CTGP (Page: B.18) or STGC (Page: B.71).

**Axial:** -6°  
**Radial:** -6°

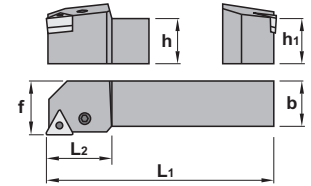
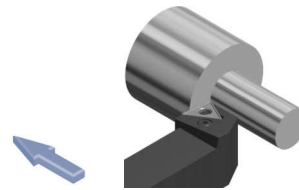

# PTGN 90°

Ref.		h=h1	b	L1	L2	f	Insert size	kg
PTGN R/L	1616 H16	16	16	100	22	20	TNM.. 1604..	0,250
	2020 K16	20	20	125	22	25	TNM.. 1604..	0,400
	2525 M16	25	25	150	22	32	TNM.. 1604..	0,750
	3225 P16	32	25	170	22	32	TNM.. 1604..	1,050
	2525 M22	25	25	150	28	32	TNM.. 2204..	0,750
	3225 P22	32	25	170	28	32	TNM.. 2204..	1,050
	3232 P22	32	32	170	28	40	TNM.. 2204..	1,300
	4040 S22	40	40	250	34	50	TNM.. 2204..	3,050
	3232 P27	32	32	170	42	40	TNM.. 2706..	1,300
	4040 S27	40	40	250	45	50	TNM.. 2706..	3,050
PTGN R/L	5050 T33	50	50	300	45	60	TNM.. 3307..	5,850

Ref.							
PTGN R/L	1616 H16	8009	1606	5025	3416	4109	0009
	2020 K16	8009	1606	5025	3416	4109	0009
	2525 M16	8009	1606	5025	3416	4109	0009
	3225 P16	8009	1606	5025	3416	4109	0009
	2525 M22	8012	1608	5003	3422	4112	0012
	3225 P22	8012	1608	5003	3422	4112	0012
	3232 P22	8012	1608	5003	3422	4112	0012
	4040 S22	8012	1608	5003	3422	4112	0012
	3232 P27	8015	1708	5003	3427	4115	0015
	4040 S27	8015	1708	5003	3427	4115	0015
PTGN R/L	5050 T33	8019	1610	5004	3433	4133	0019

Ref.	TNM..				Negative triangular inserts.						
	l	s	d	For more information see page: A.29							
	TNMA	TNMG-CFC	TNMG-CFM	TNMG-CMC	TNMG-CMF	TNMG-CMR	TNMX-R	TNMX-L			
TNM.. 1604..	16,50	4,76	9,52								
TNM.. 2204..	22,00	4,76	12,70								
TNM.. 2706..	27,50	6,35	15,88								
TNM.. 3307..	33,00	7,93	19,05								

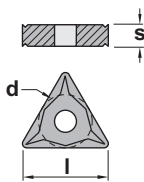

Inserts

General turning

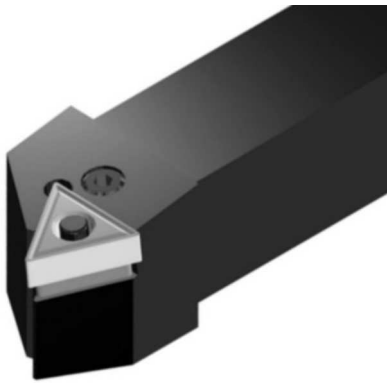

**Characteristics:**

Toolholder for external turning and chamfering applications equipped with triangular negative inserts and strong cutting edges.

The lever lock ensures good rigidity and chip flow in roughing applications.

**Applications:**

External turning and chamfering toolholder for general applications, roughing, semi-finishing and finishing.

For low powered machines and small pieces choose toolholder Ref. CTPP (Page: B.19) or STTC (Page: B.73).

**Axial:** -8°  
**Radial:** -2.25°

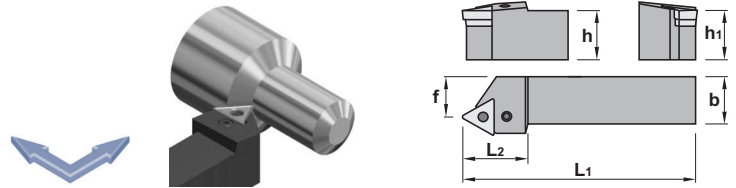

PTTN 60°		h=h <sub>1</sub>	b	L <sub>1</sub>	L <sub>2</sub>	f	Insert size	kg
Ref.	PTTN R/L 1616 H16	16	16	100	25	13	TNM.. 1604..	0,250
	PTTN R/L 2020 K16	20	20	125	28	17	TNM.. 1604..	0,400
	PTTN R/L 2525 M16	25	25	150	28	22	TNM.. 1604..	0,750
	PTTN R/L 2525 M22	25	25	150	34	22	TNM.. 2204..	0,750
	PTTN R/L 3225 P22	32	25	170	34	22	TNM.. 2204..	1,050

Ref.	PTTN R/L 1616 H16	PTTN R/L 2020 K16	PTTN R/L 2525 M16	PTTN R/L 2525 M22	PTTN R/L 3225 P22	8009	1606	5025	3416	4109	0009

Ref.	TNM..				Negative triangular inserts.			
	TNM.. 1604..	TNM.. 2204..	l	s	d	For more information see page: A.29		
	16,50	22,00	4,76	4,76	9,52	TNMG-CF	TNMG-CM	TNMG-CS
	TNMA	TNMG-CFC	TNMG-CFM	TNMG-CMC	TNMG-CMF	TNMG-CMR	TNMX-R	TNMX-L





**Characteristics:**

Multipurpose toolholder equipped with trigon negative double side insert (angle 80°) with strong cutting edge. The lever lock ensures good rigidity and chip flow in roughing applications.

**Applications:**

External turning toolholder for general applications, roughing, semi-finishing and finishing.

Top clamp toolholder Ref. MWLN (Page: B.38) or MWLN-K (Page: B.39).

**Axial:** -6°  
**Radial:** -6°

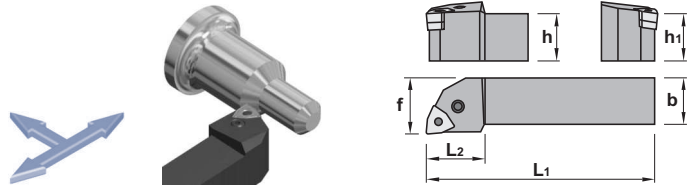

## PWLN 95°

Ref.		h=h1	b	L1	L2	f	Insert size	kg
PWLN R/L 1616 H06	PWLN R/L 1616 H06	16	16	100	15	20	WNM.. 0604..	0,250
	PWLN R/L 2020 K06	20	20	125	25	25	WNM.. 0604..	0,400
	PWLN R/L 2525 M06	25	25	150	25	32	WNM.. 0604..	0,750
PWLN R/L 2020 K08	PWLN R/L 2020 K08	20	20	125	34	25	WNM.. 0804..	0,400
	PWLN R/L 2525 M08	25	25	150	34	32	WNM.. 0804..	0,750
	PWLN R/L 3225 P08	32	25	170	34	32	WNM.. 0804..	1,050
	PWLN R/L 3232 P08	32	32	170	34	40	WNM.. 0804..	1,300

Ref.						
PWLN R/L 1616 H06	PWLN R/L 1616 H06	8009	1606	5025	3007	4109
	PWLN R/L 2020 K06	8009	1606	5025	3007	4109
	PWLN R/L 2525 M06	8009	1606	5025	3007	4109
PWLN R/L 2020 K08	PWLN R/L 2020 K08	8012	1608	5003	3008	4112
	PWLN R/L 2525 M08	8012	1608	5003	3008	4112
	PWLN R/L 3225 P08	8012	1608	5003	3008	4112
	PWLN R/L 3232 P08	8012	1608	5003	3008	4112

	WNM..				Negative 80° trigon inserts.		
	Ref.	l	s	d	WNUMG-CF	WNUMG-CM	WNUMG-CS
	WNM.. 0604..	6,45	4,76	9,52			
WNM.. 0804..	8,14	4,76	12,70				
	WNMA	WNUMG-CFM	WNUMG-CMC	WNUMG-CMF	WNUMG-CMR		

General turning

Aluminium wheel turning

Automatic lathes

Ceramic tools

Parting and grooving

Threading

Drills

Cartridges

Brazed tools

Tooling

Inserts  
General turning

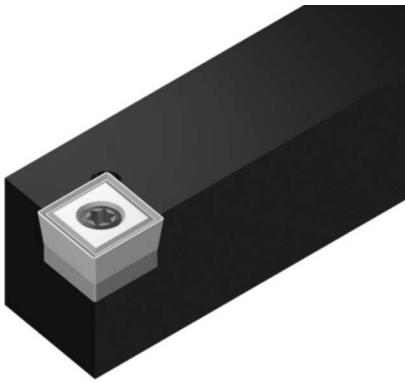

**Characteristics:**

Toolholder for external turning applications equipped with rhombic positive inserts (angle 80°). The center screw ensures good rigidity and chip flow.



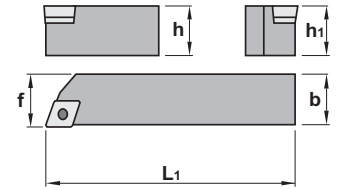
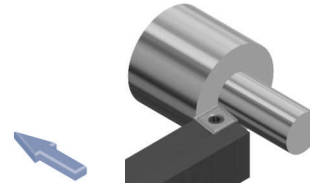

**Applications:**

External turning toolholder for all kind of materials. The workpiece should be stable.

**Axial:** 0°  
**Radial:** 0°







SCAC 90°		h=h1	b	L1	f	Insert size	kg
Ref.	SCAC R/L 0808 D06	8	8	60	8,5	CC.. 0602..	0,050
	SCAC R/L 1010 E06	10	10	70	10,5	CC.. 0602..	0,070
	SCAC R/L 1212 F09	12	12	80	12,5	CC.. 09T3..	0,100
	SCAC R/L 1616 H09	16	16	100	16,5	CC.. 09T3..	0,200
	SCAC R/L 2020 K12	20	20	125	20,5	CC.. 1204..	0,400
	SCAC R/L 2525 M12	25	25	150	25,5	CC.. 1204..	0,700

Ref.					
Ref.	SCAC R/L 0808 D06	1225	5507	-	-
	SCAC R/L 1010 E06	1225	5507	-	-
	SCAC R/L 1212 F09	1240	5515	-	-
	SCAC R/L 1616 H09	1240	5515	-	-
	SCAC R/L 2020 K12	1540	5517	3614	1760
	SCAC R/L 2525 M12	1540	5517	3614	1760

Ref.	CC..	l	s	d	Positive 7° clearance - 80° rhombic inserts.
	CC.. 0602..	6,45	2,38	6,35	
	CC.. 09T3..	9,65	3,97	9,52	
	CC.. 1204..	12,90	4,76	12,70	

For more information see page: A.18

CCGT-AL	CCGT-AP	CCMT-03	CCMW
			

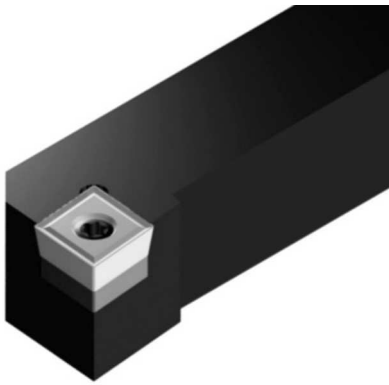
**Characteristics:**

Multipurpose toolholder equipped with rhombic positive insert (angle 80°).  
The center screw ensures good rigidity and chip flow.

**Applications:**

External turning toolholder for general applications, roughing, semi-finishing and finishing.

Negative inserts toolholders Ref. MCLN-K (Page: B.27) or MCLN (Page: B.26) or PCLN (Page: B.43).

**Axial:** 0°  
**Radial:** 0°

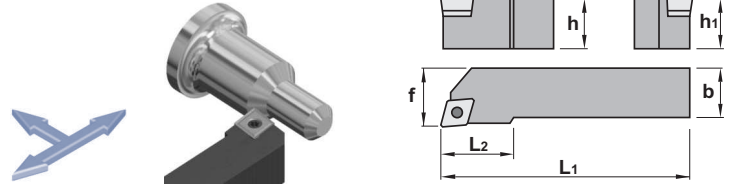
**SCLC 95°**

Ref.		h=h <sub>1</sub>	b	L <sub>1</sub>	L <sub>2</sub>	f	Insert size	kg
SCLC R/L 0808 D06		8	8	60	10	10	CC.. 0602..	0,050
	SCLC R/L 1010 E06	10	10	70	10	12	CC.. 0602..	0,070
SCLC R/L 1212 F09		12	12	80	16	16	CC.. 09T3..	0,100
SCLC R/L 1616 H09		16	16	100	16	20	CC.. 09T3..	0,200
SCLC R/L 2020 K09		20	20	125	16	25	CC.. 09T3..	0,400
SCLC R/L 2020 K12		20	20	125	25	25	CC.. 1204..	0,400
SCLC R/L 2525 M12		25	25	150	25	32	CC.. 1204..	0,700

Ref.				
SCLC R/L 0808 D06	1225	5507	-	-
SCLC R/L 1010 E06	1225	5507	-	-
SCLC R/L 1212 F09	1240	5515	-	-
SCLC R/L 1616 H09	1240	5515	-	-
SCLC R/L 2020 K09	1240	5515	-	-
SCLC R/L 2020 K12	1540	5517	3614	1760
SCLC R/L 2525 M12	1540	5517	3614	1760

Ref.	CC..				Positive 7° clearance - 80° rhombic inserts.
	l	s	d		
CC.. 0602..	6,45	2,38	6,35		For more information see page: A.18
CC.. 09T3..	9,65	3,97	9,52		
CC.. 1204..	12,90	4,76	12,70		
	CCGT-AL	CCGT-AP	CCMT-03	CCMW	

Inserts

General turning

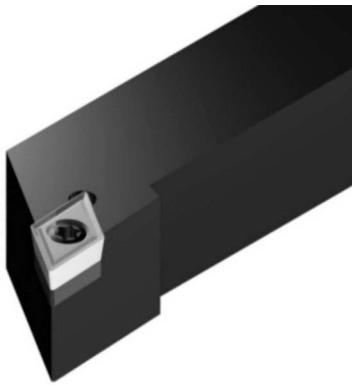

**Characteristics:**

Multipurpose profiling toolholder equipped with rhombic positive insert (angle 55°).  
The center screw ensures good rigidity and chip flow.

**Applications:**

External turning and profiling toolholder for general applications, roughing, semi-finishing and finishing.

Negative inserts toolholders Ref. MDJN-K (Page: B.28) or PDJN (Page: B.46).

**Axial:** 0°  
**Radial:** 0°

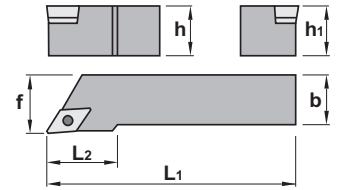
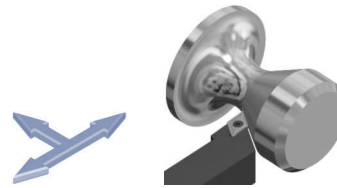

# SDJC 93°

Ref.		h=h1	b	L1	L2	f	Insert size	kg
SDJC R/L 1010 E07	SDJC R/L 1010 E07	10	10	70	16	12	DC.. 0702..	0,070
	SDJC R/L 1212 F07	12	12	80	18	16	DC.. 0702..	0,100
SDJC R/L 1212 F11	SDJC R/L 1212 F11	12	12	80	18	16	DC.. 11T3..	0,100
SDJC R/L 1616 H11	SDJC R/L 1616 H11	16	16	100	22	20	DC.. 11T3..	0,200
SDJC R/L 2020 K11	SDJC R/L 2020 K11	20	20	125	22	25	DC.. 11T3..	0,400
SDJC R/L 2525 M11	SDJC R/L 2525 M11	25	25	150	22	32	DC.. 11T3..	0,700

Ref.					
SDJC R/L 1010 E07	SDJC R/L 1010 E07	1225	5507	-	-
	SDJC R/L 1212 F07	1225	5507	-	-
SDJC R/L 1212 F11	SDJC R/L 1212 F11	1240	5515	-	-
SDJC R/L 1616 H11	SDJC R/L 1616 H11	1335	5516	3714	1750
SDJC R/L 2020 K11	SDJC R/L 2020 K11	1335	5516	3714	1750
SDJC R/L 2525 M11	SDJC R/L 2525 M11	1335	5516	3714	1750

Ref.	DC..			Positive 7° clearance - 55° rhombic inserts.
	l	s	d	
DC.. 0702..	7,75	2,38	6,35	For more information see page: A.21
DC.. 11T3..	11,60	3,97	9,52	
DCGT-AL	DCGT-AP	DCMT-03	DCMW	



**Characteristics:**

Multipurpose profiling toolholder equipped with rhombic positive insert (angle 55°). The center screw ensures good rigidity and chip flow.

**Applications:**

External turning and profiling toolholder for general applications, roughing, semi-finishing and finishing.

Negative inserts toolholders Ref. PDNN (Page: B.47).

**Axial:** 0°  
**Radial:** 0°

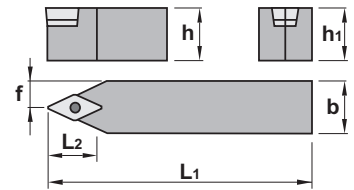
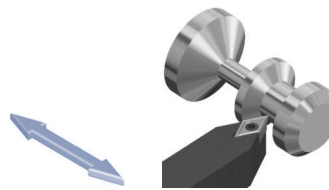

## SDNC 62°30'

Ref.		h=h1	b	L1	L2	f	Insert size	kg
SDNC N 0808 D07	SDNC N 0808 D07	8	8	60	16	4,0	DC.. 0702..	0,050
	SDNC N 1010 E07	10	10	70	16	5,0	DC.. 0702..	0,070
	SDNC N 1212 F07	12	12	80	18	6,0	DC.. 0702..	0,100
SDNC N 1616 H11	SDNC N 1616 H11	16	16	100	22	8,0	DC.. 11T3..	0,200
	SDNC N 2020 K11	20	20	125	22	10,0	DC.. 11T3..	0,400
	SDNC N 2525 M11	25	25	150	22	12,5	DC.. 11T3..	0,700

Ref.				
SDNC N 0808 D07	1225	5507	-	-
SDNC N 1010 E07	1225	5507	-	-
SDNC N 1212 F07	1225	5507	-	-
SDNC N 1616 H11	1335	5516	3714	1750
SDNC N 2020 K11	1335	5516	3714	1750
SDNC N 2525 M11	1335	5516	3714	1750

	DC..				Positive 7° clearance - 55° rhombic inserts.
	Ref.	l	s	d	
	DC.. 0702..	7,75	2,38	6,35	For more information see page: A.21
	DC.. 11T3..	11,60	3,97	9,52	
	DCGT-AL	DCGT-AP	DCMT-03	DCMW	

Inserts

General turning

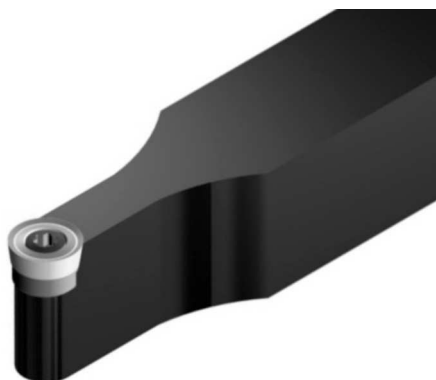

**Characteristics:**

Profiling toolholder equipped with round positive insert with strong cutting edge. The center screw ensures good rigidity and chip flow.

**Applications:**

Profiling turning toolholder for general applications, roughing, semi-finishing and finishing.



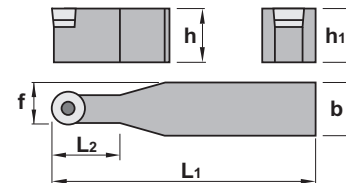
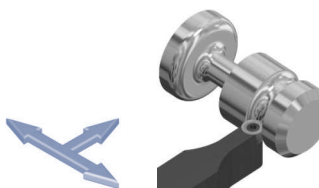

For lever lock toolholders Ref. PRDC (Page: B.48).

**Axial:** 0°  
**Radial:** 0°





**SRDC**

Ref.		h=h <sub>1</sub>	b	L <sub>1</sub>	L <sub>2</sub>	f	Insert size	kg
SRDC N	SRDC N 1010 E06	10	10	70	10	8,0	RC.. 0602M0	0,070
	SRDC N 1212 F06	12	12	80	12	11,0	RC.. 0602M0	0,100
	SRDC N 1616 H06	16	16	100	16	13,0	RC.. 0602M0	0,200
	SRDC N 2020 K06	20	20	125	20	15,0	RC.. 0602M0	0,400
	SRDC N 2525 M06	25	25	150	25	17,5	RC.. 0602M0	0,700
	SRDC N 1616 H08	16	16	100	16	13,0	RC.. 0803M0	0,200
	SRDC N 2020 K08	20	20	125	20	15,0	RC.. 0803M0	0,400
	SRDC N 2525 M08	25	25	150	25	17,5	RC.. 0803M0	0,700
	SRDC N 2020 K10	20	20	125	22	15,0	RC.. 10T3M0	0,400
	SRDC N 2525 M10	25	25	150	22	17,5	RC.. 10T3M0	0,700
SRDC N	SRDC N 2020 K12	20	20	125	28	16,0	RC.. 1204M0	0,400
	SRDC N 2525 M12	25	25	150	28	18,5	RC.. 1204M0	0,700
	SRDC N 3225 P12	32	25	170	28	18,5	RC.. 1204M0	0,900
	SRDC N 3232 P12	32	32	170	28	22,0	RC.. 1204M0	1,200

Ref.					
SRDC N	SRDC N 1010 E06	1225	5507	-	-
	SRDC N 1212 F06	1225	5507	-	-
	SRDC N 1616 H06	1225	5507	-	-
	SRDC N 2020 K06	1225	5507	-	-
	SRDC N 2525 M06	1225	5507	-	-
SRDC N	SRDC N 1616 H08	1230	5508	-	-
	SRDC N 2020 K08	1230	5508	-	-
	SRDC N 2525 M08	1230	5508	-	-
SRDC N	SRDC N 2020 K10	1335	5516	3811	1750
	SRDC N 2525 M10	1335	5516	3811	1750
SRDC N	SRDC N 2020 K12	1335	5516	3814	1750
	SRDC N 2525 M12	1335	5516	3814	1750
	SRDC N 3225 P12	1335	5516	3814	1750
	SRDC N 3232 P12	1335	5516	3814	1750

Ref.	RC..			Positive 7° clearance - Round inserts.
	s	d		
RC.. 0602M0	2,38	6,00		
RC.. 0803M0	3,18	8,00		
RC.. 10T3M0	3,97	10,00		
RC.. 1204M0	4,76	12,00		

RCGT-AL	RCGT-AP	RCMT			
					

For more information see page: A.25

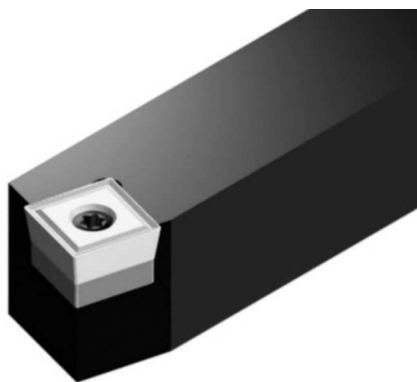

**Characteristics:**

Toolholder for external turning applications equipped with square positive inserts. The center screw ensures good rigidity and chip flow.

**Applications:**

External turning toolholder for all kind of materials. The workpiece should be stable.

Negative inserts toolholders Ref. PSBN (Page: B.51).

**Axial:** 0°  
**Radial:** 0°

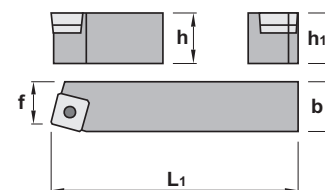
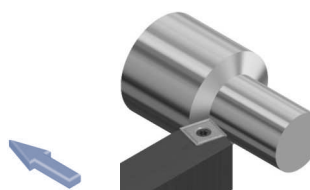

## SSBC 75°

Ref.		h=h <sub>1</sub>	b	L <sub>1</sub>	f	Insert size	kg
SSBC R/L 1212 F09	SSBC R/L 1212 F09	12	12	80	11	SC.. 09T3..	0,100
	SSBC R/L 1616 H09	16	16	100	13	SC.. 09T3..	0,200
SSBC R/L 2020 K12	SSBC R/L 2020 K12	20	20	125	17	SC.. 1204..	0,400
	SSBC R/L 2525 M12	25	25	150	22	SC.. 1204..	0,700

Ref.					
SSBC R/L 1212 F09	SSBC R/L 1212 F09	1240	5515	-	-
	SSBC R/L 1616 H09	1240	5515	-	-
SSBC R/L 2020 K12	SSBC R/L 2020 K12	1540	5517	3514	1760
	SSBC R/L 2525 M12	1540	5517	3514	1760

	SC..				Positive 7° clearance - Square inserts.
	Ref.	l	s	d	
	SC.. 09T3..	9,52	3,97	9,52	
SC.. 1204..	12,70	4,76	12,70		
	SCGT-AL	SCMT-03	SCMT-39	SCMW	

For more information see page: A.26

General turning  
Aluminium wheel turning  
Automatic lathes  
Ceramic tools  
Parting and grooving  
Threading  
Drills  
Cartridges  
Brazed tools  
Tooling



Inserts

General turning

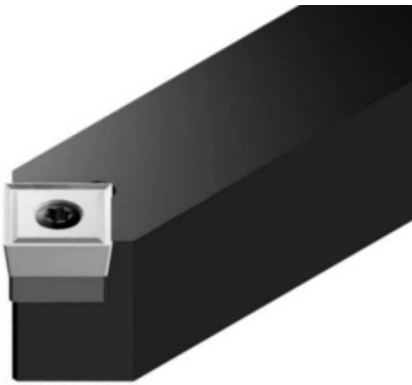

**Characteristics:**

Toolholder for external turning and chamfering applications equipped with square positive inserts. The center screw ensures good rigidity and chip flow.

**Applications:**

External turning and chamfering toolholder for all kind of materials. The workpiece should be stable.

Negative inserts toolholders Ref. PSDNN (Page: B.52).

**Axial:** 0°  
**Radial:** 0°

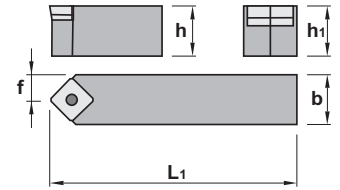
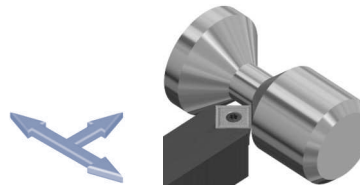

## SSDC 45°

Ref.		h=h <sub>1</sub>	b	L <sub>1</sub>	f	Insert size	kg
SSDC N 1212 F09	SSDC N 1212 F09	12	12	80	6,0	SC.. 09T3..	0,100
	SSDC N 1616 H09	16	16	100	8,0	SC.. 09T3..	0,200
SSDC N 2020 K12	SSDC N 2020 K12	20	20	125	10,0	SC.. 1204..	0,400
	SSDC N 2525 M12	25	25	150	12,5	SC.. 1204..	0,700

Ref.				
SSDC N 1212 F09	1240	5515	-	-
SSDC N 1616 H09	1240	5515	-	-
SSDC N 2020 K12	1540	5517	3514	1760
SSDC N 2525 M12	1540	5517	3514	1760

Ref.	SC..				Positive 7° clearance - Square inserts.
	l	s	d		
SC.. 09T3..	9,52	3,97	9,52		
SC.. 1204..	12,70	4,76	12,70		
	SCGT-AL	SCMT-03	SCMT-39	SCMW	

For more information see page: A.26

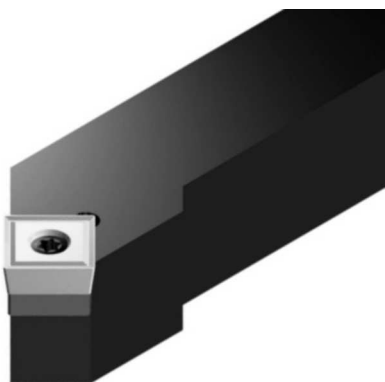

**Characteristics:**

Toolholder for external turning and chamfering applications equipped with square positive inserts. The center screw ensures good rigidity and chip flow.

**Applications:**

External turning and chamfering toolholder for all kind of materials. The workpiece should be stable.

Negative inserts toolholders Ref. PSSN (Page: B.54).

**Axial:** 0°  
**Radial:** 0°

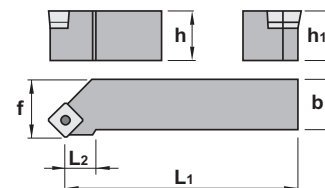
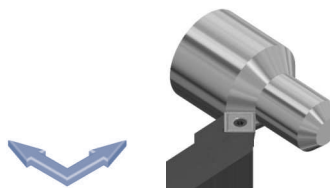

# SSSC 45°

Ref.		h=h1	b	L1	L2	f	Insert size	kg
SSSC R/L 1212 F09	SSSC R/L 1212 F09	12	12	80	11	16	SC.. 09T3..	0,100
	SSSC R/L 1616 H09	16	16	100	22	20	SC.. 09T3..	0,200
SSSC R/L 2020 K12	SSSC R/L 2020 K12	20	20	125	22	25	SC.. 1204..	0,400
	SSSC R/L 2525 M12	25	25	150	22	32	SC.. 1204..	0,700

Ref.					
SSSC R/L 1212 F09	SSSC R/L 1212 F09	1240	5515	-	-
	SSSC R/L 1616 H09	1240	5515	-	-
SSSC R/L 2020 K12	SSSC R/L 2020 K12	1540	5517	3514	1760
	SSSC R/L 2525 M12	1540	5517	3514	1760

	SC..				Positive 7° clearance - Square inserts.
	Ref.	l	s	d	
	SC.. 09T3..	9,52	3,97	9,52	
	SC.. 1204..	12,70	4,76	12,70	
	SCGT-AL	SCMT-03	SCMT-39	SCMW	

For more information see page: A.26

General turning  
Aluminium wheel turning  
Automatic lathes  
Ceramic tools  
Parting and grooving  
Threading  
Drills  
Cartridges  
Brazed tools  
Tooling

Inserts  
General turning



**Characteristics:**

Toolholder for external turning applications equipped with triangular positive inserts. The center screw ensures good rigidity and chip flow.

**Applications:**

External turning toolholder for all kind of materials. The workpiece should be stable.

**Axial:** 0°  
**Radial:** 0°

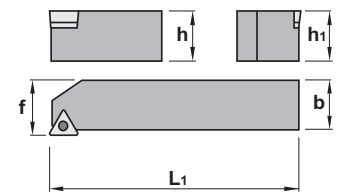
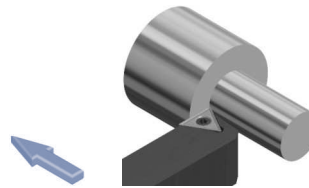

STAC 90°		h=h1	b	L1	f	Insert size	kg
Ref.	STAC R/L 0808 D09	8	8	60	8,5	TC.. 0902..	0,050
	STAC R/L 1010 E09	10	10	70	10,5	TC.. 0902..	0,070
	STAC R/L 1212 F11	12	12	80	12,5	TC.. 1102..	0,100
	STAC R/L 1616 H11	16	16	100	16,5	TC.. 1102..	0,200
	STAC R/L 1616 H16	16	16	100	16,5	TC.. 16T3..	0,200
	STAC R/L 2020 K16	20	20	125	20,5	TC.. 16T3..	0,400
	STAC R/L 2525 M16	25	25	150	25,5	TC.. 16T3..	0,700

Ref.	STAC R/L 0808 D09	STAC R/L 1010 E09	STAC R/L 1212 F11	STAC R/L 1616 H11	STAC R/L 1616 H16	STAC R/L 2020 K16	STAC R/L 2525 M16
	1222	1222	1225	1225	1335	1335	1335
	5506	5506	5507	5507	5516	5516	5516
	-	-	-	-	3414	3414	3414
	-	-	-	-	1750	1750	1750

Ref.	TC..	l	s	d	Positive 7° clearance - Triangular inserts.
	TC.. 0902..	9,62	2,38	5,55	
TC.. 1102..	11,00	2,38	6,35		
TC.. 16T3..	16,50	3,97	9,52		

TCGT-AL	TCMT-03	TCMW			

For more information see page: A.28

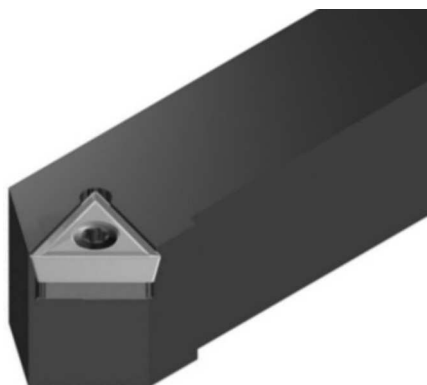

**Characteristics:**

Toolholder for external turning and chamfering applications equipped with triangular positive inserts. The center screw ensures good rigidity and chip flow.

**Applications:**

External turning and chamfering toolholder for all kind of materials. The workpiece should be stable.

Negative inserts toolholders Ref. PTDN (Page: B.55).

**Axial:** 0°  
**Radial:** 0°

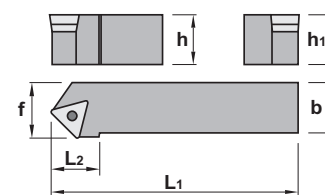
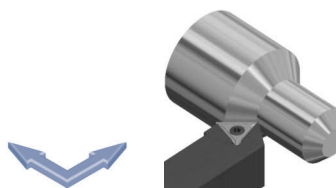

# STDC 45°

Ref.		h=h1	b	L1	L2	f	Insert size	kg
STDC R/L 0808 D09	STDC R/L 0808 D09	8	8	60	11	10	TC.. 0902..	0,050
	STDC R/L 1010 E09	10	10	70	11	11	TC.. 0902..	0,070
STDC R/L 1212 F11	STDC R/L 1212 F11	12	12	80	16	13	TC.. 1102..	0,100
	STDC R/L 1616 H11	16	16	100	16	17	TC.. 1102..	0,200
STDC R/L 1212 F16	STDC R/L 1212 F16	12	12	80	21	17	TC.. 16T3..	0,100
	STDC R/L 1616 H16	16	16	100	21	17	TC.. 16T3..	0,200
STDC R/L 2020 K16	STDC R/L 2020 K16	20	20	125	21	22	TC.. 16T3..	0,400
STDC R/L 2525 M16	STDC R/L 2525 M16	25	25	150	21	27	TC.. 16T3..	0,700

Ref.				
STDC R/L 0808 D09	1222	5506	-	-
STDC R/L 1010 E09	1222	5506	-	-
STDC R/L 1212 F11	1225	5507	-	-
STDC R/L 1616 H11	1225	5507	-	-
STDC R/L 1212 F16	1240	5515	-	-
STDC R/L 1616 H16	1335	5516	3414	1750
STDC R/L 2020 K16	1335	5516	3414	1750
STDC R/L 2525 M16	1335	5516	3414	1750

Ref.	TC..			Positive 7° clearance - Triangular inserts.
	l	s	d	
TC.. 0902..	9,62	2,38	5,55	For more information see page: A.28
TC.. 1102..	11,00	2,38	6,35	
TC.. 16T3..	16,50	3,97	9,52	
	TCGT-AL	TCMT-03	TCMW	

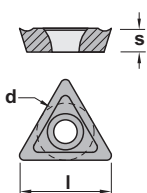

General turning  
Aluminium wheel turning  
Automatic lathes  
Ceramic tools  
Parting and grooving  
Threading  
Drills  
Cartridges  
Brazed tools  
Tooling

Inserts

General turning

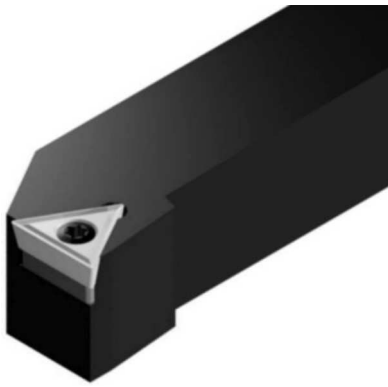

**Characteristics:**

Toolholder for face turning applications equipped with triangular positive inserts. The center screw ensures good rigidity and chip flow.

**Applications:**

Face turning toolholder for all kind of materials. The workpiece should be stable.



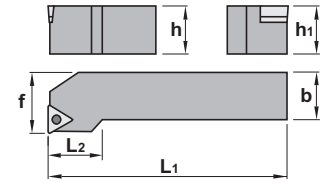
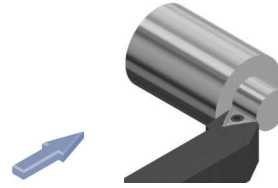

Negative inserts toolholders Ref. PTFN (Page: B.56).

**Axial:** 0°  
**Radial:** 0°





# STFC 90°

Ref.		h=h <sub>1</sub>	b	L <sub>1</sub>	L <sub>2</sub>	f	Insert size	kg
STFC R/L 0808 D09	STFC R/L 0808 D09	8	8	60	16	10	TC.. 0902..	0,050
	STFC R/L 1010 E09	10	10	70	16	12	TC.. 0902..	0,070
STFC R/L 1212 F11	STFC R/L 1212 F11	12	12	80	18	16	TC.. 1102..	0,100
	STFC R/L 1616 H11	16	16	100	22	20	TC.. 1102..	0,200
STFC R/L 1212 F16	STFC R/L 1212 F16	12	12	80	18	16	TC.. 16T3..	0,100
	STFC R/L 1616 H16	16	16	100	22	20	TC.. 16T3..	0,200
STFC R/L 2020 K16	STFC R/L 2020 K16	20	20	125	22	25	TC.. 16T3..	0,400
STFC R/L 2525 M16	STFC R/L 2525 M16	25	25	150	22	32	TC.. 16T3..	0,700

Ref.					
STFC R/L 0808 D09	STFC R/L 0808 D09	1222	5506	-	-
	STFC R/L 1010 E09	1222	5506	-	-
STFC R/L 1212 F11	STFC R/L 1212 F11	1225	5507	-	-
	STFC R/L 1616 H11	1225	5507	-	-
STFC R/L 1212 F16	STFC R/L 1212 F16	1240	5515	-	-
	STFC R/L 1616 H16	1335	5516	3414	1750
STFC R/L 2020 K16	STFC R/L 2020 K16	1335	5516	3414	1750
STFC R/L 2525 M16	STFC R/L 2525 M16	1335	5516	3414	1750

Ref.	TC..	l	s	d	Positive 7° clearance - Triangular inserts.
	TC.. 0902..	9,62	2,38	5,55	
TC.. 1102..	11,00	2,38	6,35		
TC.. 16T3..	16,50	3,97	9,52		

TCGT-AL	TCMT-03	TCMW			
					

For more information see page: A.28

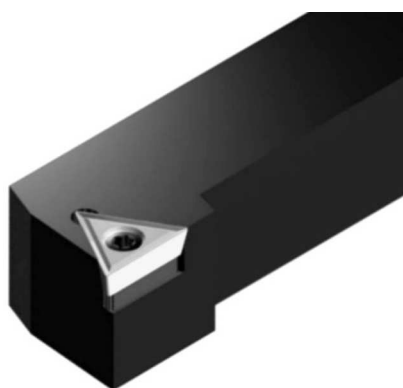

**Characteristics:**

Toolholder for external turning applications equipped with triangular positive inserts. The center screw ensures good rigidity and chip flow.

**Applications:**

External turning toolholder for all kind of materials. The workpiece should be stable.

Negative inserts toolholders Ref. PTGN (Page: B.57).

**Axial:** 0°  
**Radial:** 0°

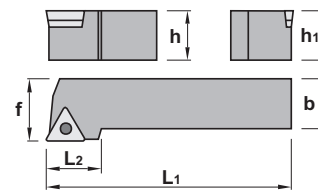
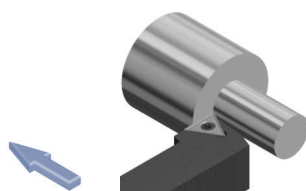

## STGC 90°

Ref.		h=h <sub>1</sub>	b	L <sub>1</sub>	L <sub>2</sub>	f	Insert size	kg
STGC R/L 0808 D09	STGC R/L 0808 D09	8	8	60	16	10	TC.. 0902..	0,050
	STGC R/L 1010 E09	10	10	70	16	12	TC.. 0902..	0,070
STGC R/L 1212 F11	STGC R/L 1212 F11	12	12	80	18	16	TC.. 1102..	0,100
	STGC R/L 1616 H11	16	16	100	22	20	TC.. 1102..	0,200
STGC R/L 1212 F16	STGC R/L 1212 F16	12	12	80	18	16	TC.. 16T3..	0,100
	STGC R/L 1616 H16	16	16	100	22	20	TC.. 16T3..	0,200
STGC R/L 2020 K16	STGC R/L 2020 K16	20	20	125	22	25	TC.. 16T3..	0,400
STGC R/L 2525 M16	STGC R/L 2525 M16	25	25	150	22	32	TC.. 16T3..	0,700

Ref.				
STGC R/L 0808 D09	1222	5506	-	-
STGC R/L 1010 E09	1222	5506	-	-
STGC R/L 1212 F11	1225	5507	-	-
STGC R/L 1616 H11	1225	5507	-	-
STGC R/L 1212 F16	1240	5515	-	-
STGC R/L 1616 H16	1335	5516	3414	1750
STGC R/L 2020 K16	1335	5516	3414	1750
STGC R/L 2525 M16	1335	5516	3414	1750

Ref.	TC..			Positive 7° clearance - Triangular inserts.
	l	s	d	
TC.. 0902..	9,62	2,38	5,55	For more information see page: A.28
TC.. 1102..	11,00	2,38	6,35	
TC.. 16T3..	16,50	3,97	9,52	
	TCGT-AL	TCMT-03	TCMW	

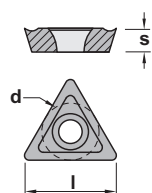

Inserts

General turning

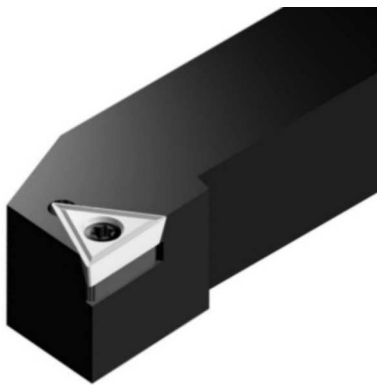

**Characteristics:**

Toolholder for external and face turning applications equipped with triangular positive inserts. The center screw ensures good rigidity and chip flow.

**Applications:**

External and face turning toolholder for all kind of materials. The workpiece should be stable.



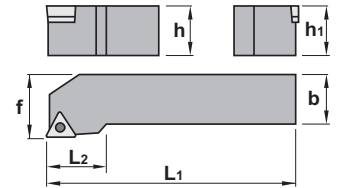
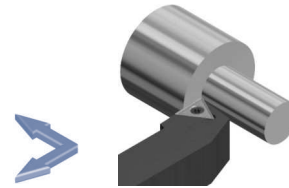

Negative inserts toolholders Ref. MTJN (Page: B.32) or MTJN-K (Page: B.33).

**Axial:** 0°  
**Radial:** 0°





# STJC 93°

Ref.		h=h <sub>1</sub>	b	L <sub>1</sub>	L <sub>2</sub>	f	Insert size	kg
Ref.	STJC R/L 0808 D09	8	8	60	16	10	TC.. 0902..	0,050
	STJC R/L 1010 E09	10	10	70	16	12	TC.. 0902..	0,070
	STJC R/L 1212 F11	12	12	80	18	16	TC.. 1102..	0,100
	STJC R/L 1616 H11	16	16	100	22	20	TC.. 1102..	0,200
	STJC R/L 1212 F16	12	12	80	18	16	TC.. 16T3..	0,100
	STJC R/L 1616 H16	16	16	100	22	20	TC.. 16T3..	0,200
	STJC R/L 2020 K16	20	20	125	22	25	TC.. 16T3..	0,400
	STJC R/L 2525 M16	25	25	150	22	32	TC.. 16T3..	0,700

Ref.					
Ref.	STJC R/L 0808 D09	1222	5506	-	-
	STJC R/L 1010 E09	1222	5506	-	-
	STJC R/L 1212 F11	1225	5507	-	-
	STJC R/L 1616 H11	1225	5507	-	-
	STJC R/L 1212 F16	1240	5515	-	-
	STJC R/L 1616 H16	1335	5516	3414	1750
	STJC R/L 2020 K16	1335	5516	3414	1750
	STJC R/L 2525 M16	1335	5516	3414	1750

Ref.	TC..	l	s	d	Positive 7° clearance - Triangular inserts.
	TC.. 0902..	9,62	2,38	5,55	
TC.. 1102..	11,00	2,38	6,35		
TC.. 16T3..	16,50	3,97	9,52		

TCGT-AL	TCMT-03	TCMW			
					

For more information see page: A.28





**Characteristics:**

Toolholder for external turning and chamfering applications equipped with triangular positive inserts. The center screw ensures good rigidity and chip flow.

**Applications:**

External turning and chamfering toolholder for all kind of materials. The workpiece should be stable.

Negative inserts toolholders Ref. PTTN (Page: B.58).

**Axial:** 0°  
**Radial:** 0°

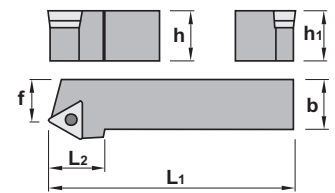
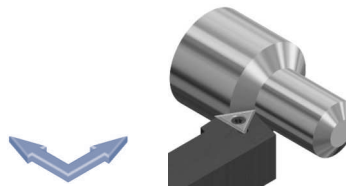

# STTC 60°

Ref.		h=h1	b	L1	L2	f	Insert size	kg
STTC R/L 0808 D09	STTC R/L 0808 D09	8	8	60	16	7	TC.. 0902..	0,050
	STTC R/L 1010 E09	10	10	70	16	9	TC.. 0902..	0,070
STTC R/L 1212 F11	STTC R/L 1212 F11	12	12	80	18	11	TC.. 1102..	0,100
	STTC R/L 1616 H11	16	16	100	18	13	TC.. 1102..	0,200
STTC R/L 1212 F16	STTC R/L 1212 F16	12	12	80	22	11	TC.. 16T3..	0,100
	STTC R/L 1616 H16	16	16	100	22	13	TC.. 16T3..	0,200
STTC R/L 2020 K16	STTC R/L 2020 K16	20	20	125	22	17	TC.. 16T3..	0,400
STTC R/L 2525 M16	STTC R/L 2525 M16	25	25	150	22	22	TC.. 16T3..	0,700

Ref.				
STTC R/L 0808 D09	1222	5506	-	-
STTC R/L 1010 E09	1222	5506	-	-
STTC R/L 1212 F11	1225	5507	-	-
STTC R/L 1616 H11	1225	5507	-	-
STTC R/L 1212 F16	1240	5515	-	-
STTC R/L 1616 H16	1335	5516	3414	1750
STTC R/L 2020 K16	1335	5516	3414	1750
STTC R/L 2525 M16	1335	5516	3414	1750

Ref.	TC..			Positive 7° clearance - Triangular inserts.
	l	s	d	
TC.. 0902..	9,62	2,38	5,55	For more information see page: A.28
TC.. 1102..	11,00	2,38	6,35	
TC.. 16T3..	16,50	3,97	9,52	
	TCGT-AL	TCMT-03	TCMW	

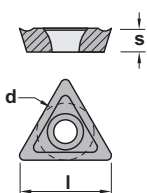

General turning  
Aluminium wheel turning  
Automatic lathes  
Ceramic tools  
Parting and grooving  
Threading  
Drills  
Cartridges  
Brazed tools  
Tooling

Inserts

General turning



**Characteristics:**

Multipurpose profiling toolholder equipped with rhombic positive insert (angle 35°).  
The center screw ensures good rigidity and chip flow.

**Applications:**

External turning and profiling toolholder for general applications, semi-finishing and finishing.

**Axial:** 0°  
**Radial:** 0°

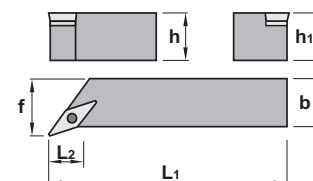
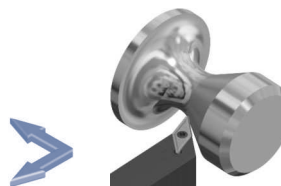

## SVHC 107°30'

Ref.		h=h <sub>1</sub>	b	L <sub>1</sub>	L <sub>2</sub>	f	Insert size	kg
SVHC R/L 2020 K16	SVHC R/L 2020 K16	20	20	125	15,4	25	VC.. 1604..	0,400
	SVHC R/L 2525 M16	25	25	150	21,0	32	VC.. 1604..	0,700
	SVHC R/L 3225 P16	32	25	170	21,0	32	VC.. 1604..	0,900
SVHC R/L 2525 M22	SVHC R/L 2525 M22	25	25	150	19,6	32	VC.. 2205..	0,700
	SVHC R/L 3225 P22	32	25	170	19,6	32	VC.. 2205..	0,900

Ref.				
SVHC R/L 2020 K16	1335	5516	3718	1750
SVHC R/L 2525 M16	1335	5516	3718	1750
SVHC R/L 3225 P16	1335	5516	3718	1750
SVHC R/L 2525 M22	1540	5520	3722	1760
SVHC R/L 3225 P22	1540	5520	3722	1760

Ref.	VC..				Positive 7° clearance - 35° rhombic inserts	
	l	s	d			
VC.. 1604..	16,50	4,76	9,52			
VC.. 2205..	22,10	5,56	12,70			
For more information see page: A.32						
VCGT-AL	VCGT-AL	VCGT-AP	VCGT-AP	VCMT-03		

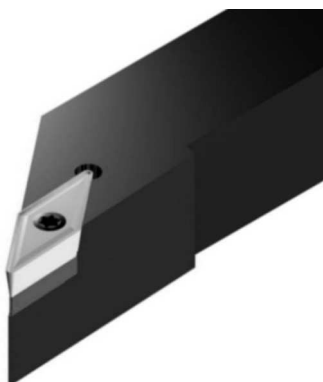

**Characteristics:**

Multipurpose profiling toolholder equipped with rhombic 5° positive insert (angle 35°).  
The center screw ensures good rigidity and chip flow.

**Applications:**

External turning and profiling toolholder for general applications, semi-finishing and finishing.

Negative inserts toolholders Ref. MVJN-K (Page: B.35).

**Axial:** 0°  
**Radial:** 0°

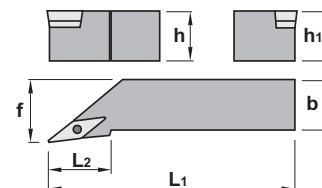
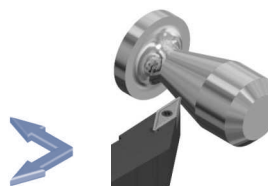

# SVJB 93°

Ref.		h=h1	b	L1	L2	f	Insert size	kg
SVJB R/L 2020 K16		20	20	125	37	25	VBMT 1604..	0,400
SVJB R/L 2525 M16		25	25	150	37	32	VBMT 1604..	0,700
SVJB R/L 3225 P16		32	25	170	37	32	VBMT 1604..	0,900

Ref.				
SVJB R/L 2020 K16	1335	5516	3718	1750
SVJB R/L 2525 M16	1335	5516	3718	1750
SVJB R/L 3225 P16	1335	5516	3718	1750

 <b>VBMT</b>	<b>VBMT</b>			Positive 5° clearance - 35° rhombic inserts.  For more information see page: A.32
	Ref.	l	s	
	VBMT 1604..	16,50	4,76	9,52
 <b>VBMT</b>				

General turning

Aluminium wheel turning

Automatic lathes

Ceramic tools

Parting and grooving

Threading

Drills

Cartridges

Brazed tools

Tooling

Inserts  
General turning

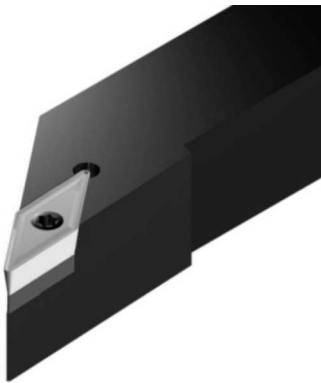

**Characteristics:**

Multipurpose profiling toolholder equipped with rhombic positive insert (angle 35°).  
The center screw ensures good rigidity and chip flow.

**Applications:**

External turning and profiling toolholder for general applications, semi-finishing and finishing.

Negative inserts toolholders Ref. MVJN-K (Page: B.35).

**Axial:** 0°  
**Radial:** 0°

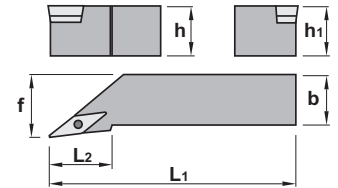
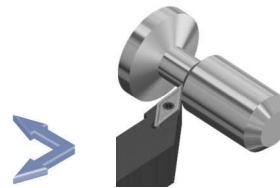

SVJC 93°		h=h1	b	L1	L2	f	Insert size	kg
Ref.	SVJC R/L 1212 F11	12	12	80	25	16	VC.. 1103..	0,100
	SVJC R/L 1616 H11	16	16	100	25	20	VC.. 1103..	0,200
	SVJC R/L 2020 K11	20	20	125	25	25	VC.. 1103..	0,400
	SVJC R/L 2020 K16	20	20	125	37	25	VC.. 1604..	0,400
	SVJC R/L 2525 M16	25	25	150	37	32	VC.. 1604..	0,700
	SVJC R/L 3225 P16	32	25	170	37	32	VC.. 1604..	0,900

Ref.	SVJC R/L 1212 F11	SVJC R/L 1616 H11	SVJC R/L 2020 K11	SVJC R/L 2020 K16	SVJC R/L 2525 M16	SVJC R/L 3225 P16
	1225	1225	1225	1335	1335	1335
				5516	5516	5516
					3718	3718
						1750
						1750
						1750

Ref.	VC..			Positive 7° clearance - 35° rhombic inserts
	l	s	d	
VC.. 1103..	11,00	3,18	6,35	For more information see page: A.32
VC.. 1604..	16,50	4,76	9,52	
VCGT-AL	VCGT-AP	VCMT-03		



**Characteristics:**

Multipurpose profiling toolholder equipped with rhombic positive insert (angle 35°).  
The center screw ensures good rigidity and chip flow.

**Applications:**

External turning and profiling toolholder for general applications, semi-finishing and finishing.

**Axial:** 0°  
**Radial:** 0°

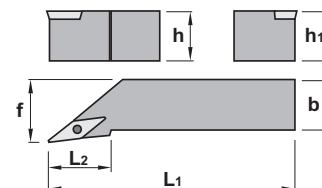
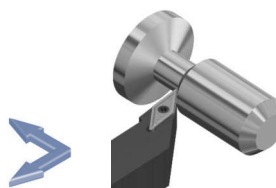

## SVLC 95°

Ref.		h=h <sub>1</sub>	b	L <sub>1</sub>	L <sub>2</sub>	f	Insert size	kg
	SVLC R/L 1212 G13	12	12	90	25	16	VCMT 1303..	0,100
	SVLC R/L 1616 H13	16	16	100	25	20	VCMT 1303..	0,200
	SVLC R/L 2020 K13	20	20	125	28	25	VCMT 1303..	0,400
	SVLC R/L 2525 M13	25	25	150	30	32	VCMT 1303..	0,700

Ref.			
	SVLC R/L 1212 G13	1230	5508
	SVLC R/L 1616 H13	1230	5508
	SVLC R/L 2020 K13	1230	5508
	SVLC R/L 2525 M13	1230	5508

 VCMT-03 	VCMT			Positive 7° clearance - 35° rhombic inserts.
	Ref.	l	s	
	VC.. 1303..	13,00	3,18	8,00

For more information see page: A.32

General turning  
Aluminium wheel turning  
Automatic lathes  
Ceramic tools  
Parting and grooving  
Threading  
Drills  
Cartridges  
Brazed tools  
Tooling

Inserts

General turning

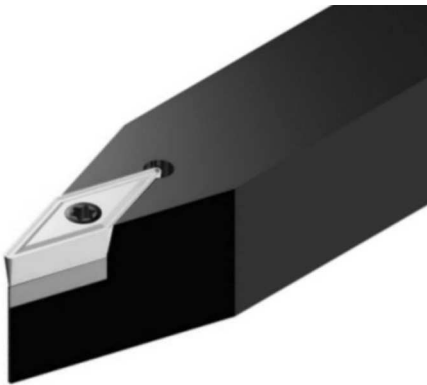

**Characteristics:**

Multipurpose profiling toolholder equipped with rhombic 5° positive insert (angle 35°).  
The center screw ensures good rigidity and chip flow.

**Applications:**

External turning and profiling toolholder for general applications, semi-finishing and finishing.

Negative inserts toolholders Ref. MVVN-K (Page: B.37).

**Axial:** 0°  
**Radial:** 0°

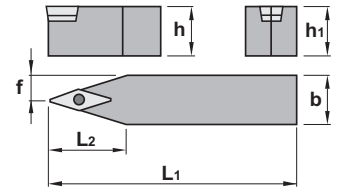
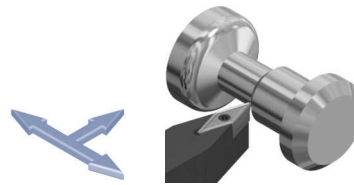

SVVB 72°30'		h=h <sub>1</sub>	b	L <sub>1</sub>	L <sub>2</sub>	f	Insert size	kg
Ref.	SVVB N 2020 K16	20	20	125	37	10,6	VBMT 1604..	0,400
	SVVB N 2525 M16	25	25	150	37	13,1	VBMT 1604..	0,700
	SVVB N 3225 P16	32	25	170	37	13,1	VBMT 1604..	0,900

Ref.				
SVVB N 2020 K16	1335	5516	3718	1750
SVVB N 2525 M16	1335	5516	3718	1750
SVVB N 3225 P16	1335	5516	3718	1750

VBMT		l	s	d	Positive 5° clearance - 35° rhombic inserts.
Ref.	VBMT 1604..	16,50	4,76	9,52	
For more information see page: A.32					
	VBMT				

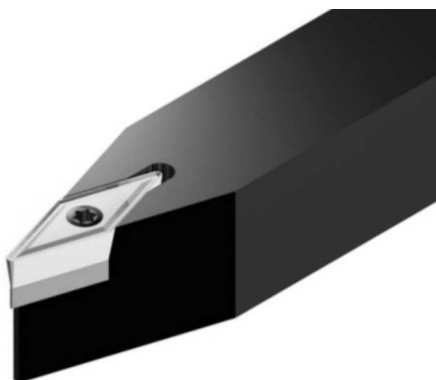

**Characteristics:**

Multipurpose profiling toolholder equipped with rhombic positive insert (angle 35°).  
The center screw ensures good rigidity and chip flow.

**Applications:**

External turning and profiling toolholder for general applications, semi-finishing and finishing.

Negative inserts toolholders Ref. MVVN-K (Page: B.37).

**Axial:** 0°  
**Radial:** 0°

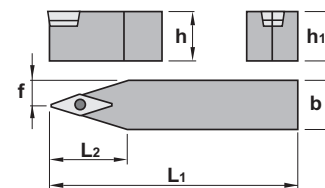
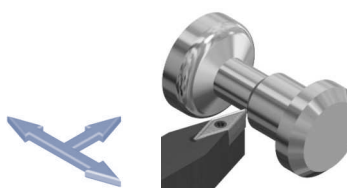

## SVVC 72°30'

Ref.		h=h1	b	L1	L2	f	Insert size	kg
SVVC N 1212 F11	SVVC N 1212 F11	12	12	80	25	6,6	VC.. 1103..	0,100
	SVVC N 1616 H11	16	16	100	25	8,6	VC.. 1103..	0,200
	SVVC N 2020 K11	20	20	125	25	10,6	VC.. 1103..	0,400
SVVC N 2020 K16	SVVC N 2020 K16	20	20	125	37	10,6	VC.. 1604..	0,400
	SVVC N 2525 M16	25	25	150	37	13,1	VC.. 1604..	0,700
	SVVC N 3225 P16	32	25	170	37	13,1	VC.. 1604..	0,900

Ref.				
SVVC N 1212 F11	1225	5507	-	-
SVVC N 1616 H11	1225	5507	-	-
SVVC N 2020 K11	1225	5507	-	-
SVVC N 2020 K16	1335	5516	3718	1750
SVVC N 2525 M16	1335	5516	3718	1750
SVVC N 3225 P16	1335	5516	3718	1750

	VC..				Positive 7° clearance - 35° rhombic inserts
	Ref.	l	s	d	
	VC.. 1103..	11,00	3,18	6,35	
VC.. 1604..	16,50	4,76	9,52		
For more information see page: A.32					
VCGT-AL	VCGT-AP	VCMT-03			

General turning  
Aluminium wheel turning  
Automatic lathes  
Ceramic tools  
Parting and grooving  
Threading  
Drills  
Cartridges  
Brazed tools  
Tooling



Inserts  
General turning



**Characteristics:**

Multipurpose profiling toolholder equipped with rhombic positive insert (angle 35°).  
The center screw ensures good rigidity and chip flow.

**Applications:**

External turning and profiling toolholder for general applications, semi-finishing and finishing.

**Axial:** 0°  
**Radial:** 0°

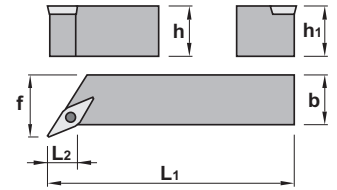
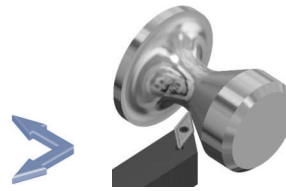

## SVXC 113°

Ref.		h=h <sub>1</sub>	b	L <sub>1</sub>	L <sub>2</sub>	f	Insert size	kg
	<b>SVXC R/L 1212 G13</b>	12	12	90	11,5	16	VCMT 1303..	0,100
	<b>SVXC R/L 1616 H13</b>	16	16	100	13,8	20	VCMT 1303..	0,200
	<b>SVXC R/L 2020 K13</b>	20	20	125	10,4	25	VCMT 1303..	0,400
	<b>SVXC R/L 2525 M13</b>	25	25	150	20,2	32	VCMT 1303..	0,700

Ref.			
	<b>SVXC R/L 1212 G13</b>	1230	5508
	<b>SVXC R/L 1616 H13</b>	1230	5508
	<b>SVXC R/L 2020 K13</b>	1230	5508
	<b>SVXC R/L 2525 M13</b>	1230	5508

Ref.	VCMT			Positive 7° clearance - 35° rhombic inserts.
	l	s	d	
<b>VC.. 1303..</b>	13,00	3,18	8,00	For more information see page: A.32
<b>VCMT-03</b>				

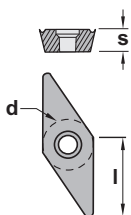

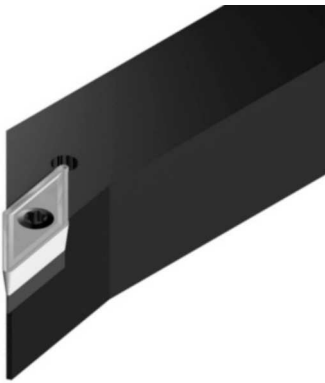

**Characteristics:**

Multipurpose profiling toolholder equipped with rhombic positive insert (angle 35°).  
The center screw ensures good rigidity and chip flow.

**Applications:**

External turning and profiling toolholder for general applications, semi-finishing and finishing.

**Axial:** 0°  
**Radial:** 0°

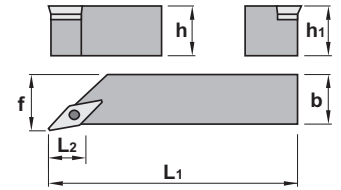
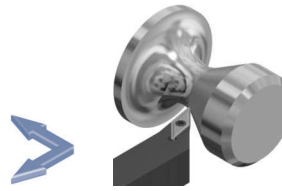

## SVZC 100°

Ref.		h=h1	b	L1	L2	f	Insert size	kg
SVZC R/L 2020 K16		20	20	125	25,7	25	VC.. 1604..	0,400
SVZC R/L 2525 M16		25	25	150	28,5	32	VC.. 1604..	0,700
SVZC R/L 3225 P16		32	25	170	28,5	32	VC.. 1604..	0,900

Ref.				
SVZC R/L 2020 K16	1335	5516	3718	1750
SVZC R/L 2525 M16	1335	5516	3718	1750
SVZC R/L 3225 P16	1335	5516	3718	1750

	VC..				Positive 7° clearance - 35° rhombic inserts
	Ref.	l	s	d	
	VC.. 1604..	16,50	4,76	9,52	
	VCGT-AL	VCGT-AP	VCMT-03		

For more information see page: A.32

## Nominal cutting speed and feed values for toolholders

Material	P	HB	Condition	Cutting speed m/min.						Specific cutting force K <sub>c,0.4</sub>
				PM 25	PM 40	NC 25	TIN 16	TIN 22	TIN 32	
				0.3-0.6-1.2		0.1 - 0.3	0.1-0.4-0.8	0.1-0.4-0.8	0.2-0.5-1.2	
Unalloyed steel	125	C=0.15%	150 115 80		350 280	480 345 250	440 300 205	330 230 110	1900	
	150	C=0.35%	145 105 70		270 230	440 315 230	400 275 190	300 210 150	2100	
	200	C=0.60%	115 90 65		240 190	385 275 200	350 240 165	260 185 130	2250	
Low alloyed steel	180	Annealed	90 70 45		300 260	380 265 195	320 220 170	200 140 100	2100	
	275	Hardened	65 45 30		220 140	260 180 130	215 150 115	140 100 70	2600	
	300	Hardened	60 40 25		230 180	240 165 120	200 135 105	125 90 60	2700	
	350	Hardened	50 35 20		220 140	210 145 105	170 120 90	110 75 55	2850	
High alloyed steel	200	Annealed	80 60 45		200 160	350 230 170	280 185 135	175 115 80	2600	
	325	Hardened	40 25 20		200 160	170 110	120 80 60	85 55 40	3900	
Stainless steel	200	Martensitic/Ferritic	110 95 75		270 130	295 240 190	275 210 165	225 180 145	2300	
Steel castings	180	Unalloyed	60 50 35		300 260	260 185 145	230 160 120	135 105 75	2000	
	200	Low alloyed	50 45 30		230 180	230 160 120	190 125 85	120 90 60	2500	
	225	High alloyed	40 30 20		220 140	190 130 95	170 115 80	95 70 55	2700	

Material	M	HB	Condition	Cutting speed m/min.						Specific cutting force K <sub>c,0.4</sub>		
				PM 25	PM 40	NC 25	TIN 16	TIN 17	TIN 22		TIN 32	TIN 35
				0.1-0.3		0.1-0.3	0.1-0.4-0.8	0.1-0.3			0.2-0.4-0.6	0.2-0.4-0.6
Stainless steel annealed	180	Austenitic Ni > 8%, Cr 12-25% Austenitic/Ferritic Austenitic/Ferritic, Low S	205 170		240 200	180 150 120	600 100		190 160 130	190 160 130	2450	
					160 130	180 150 120	400 100		190 160 100	190 160 130		
					160 130	180 150 120	400 100		140 110	160 130 100		
Heat resistant alloys	200	Annealed				50 20		40 20	40 20	3000		
	280	Aged				50 20		35 15	35 15	3050		
	250	Annealed				40 15		25 6	25 8	3500		
	350	Aged				35 20		15 4	15 4	4150		
	320	Cast				25 10		15 4	15 4	4150		
Titanium alloys	400	Ti				140 80			80 130	1530		
	950	Cast a, almost a and a+b				45 25			15 35	1675		
	1050	Aged cast a+b				45 25			15 35	1690		

Material	K	HB	Condition	Cutting speed m/min.						Specific cutting force K <sub>c,0.4</sub>
				KM 15	TIN 17	NC 25	TIN 16	TIN 22	ZR 10	
				0.2-0.5-1.0	0.2-0.5-1.0	0.2-0.5	0.2-0.5-1.0		0.2-0.5-1.0	
Hardened steel	350	Hardened steel	27 16 10	180 150 110		175 145 100			4500	
	250	Manganese steel 12%	65 40 16	120 90 60		120 85 50			3600	
Malleable cast iron	130	Ferritic	105 75 45	250 180 100		225 150 90			1100	
	230	Pearlitic	80 60 30	160 100 60		155 95 55			1100	
Cast iron	180	Low tensile strenght	135 95 60	180 120 80	300 200	165 110 70			1100	
	260	High tensile strenght	95 65 40	140 105 60	250 180	120 90 55			1500	
Nodular SG iron	160	Ferritic	115 80 45	220 180 100	250 180				1100	
	250	Pearlitic	80 50 30	150 100 50	180 120				1800	
Chilled cast iron	400		17 11	17 11					3000	
Aluminium alloys	60	Non heat treatable	1750 1280 800	1750 1280 800				1750 1280 800	500	
	100	Heat treatable	510 370 250	510 370 250				510 370 250	800	
Aluminium alloys (Cast)	75	Non heat treatable	460 285 175	460 285 175				460 285 175	750	
	90	Heat treatable	300 180 110	300 180 110				300 180 110	900	
Bronze-Brass alloys	110	Lead alloys, Pb>1%	610 430 295	610 430 295				610 430 295	700	
	90	Brass and bronze	310 250 195	310 250 195				310 250 195	750	
	100	Inc. electrolytic copper	225 160 115	225 160 115				225 160 115	1750	
Other materials		Hard plastics	380 240	380 240				380 240		
		Fibre	190 120	190 120				190 120		
		Hard rubber	225 160	225 160				225 160		





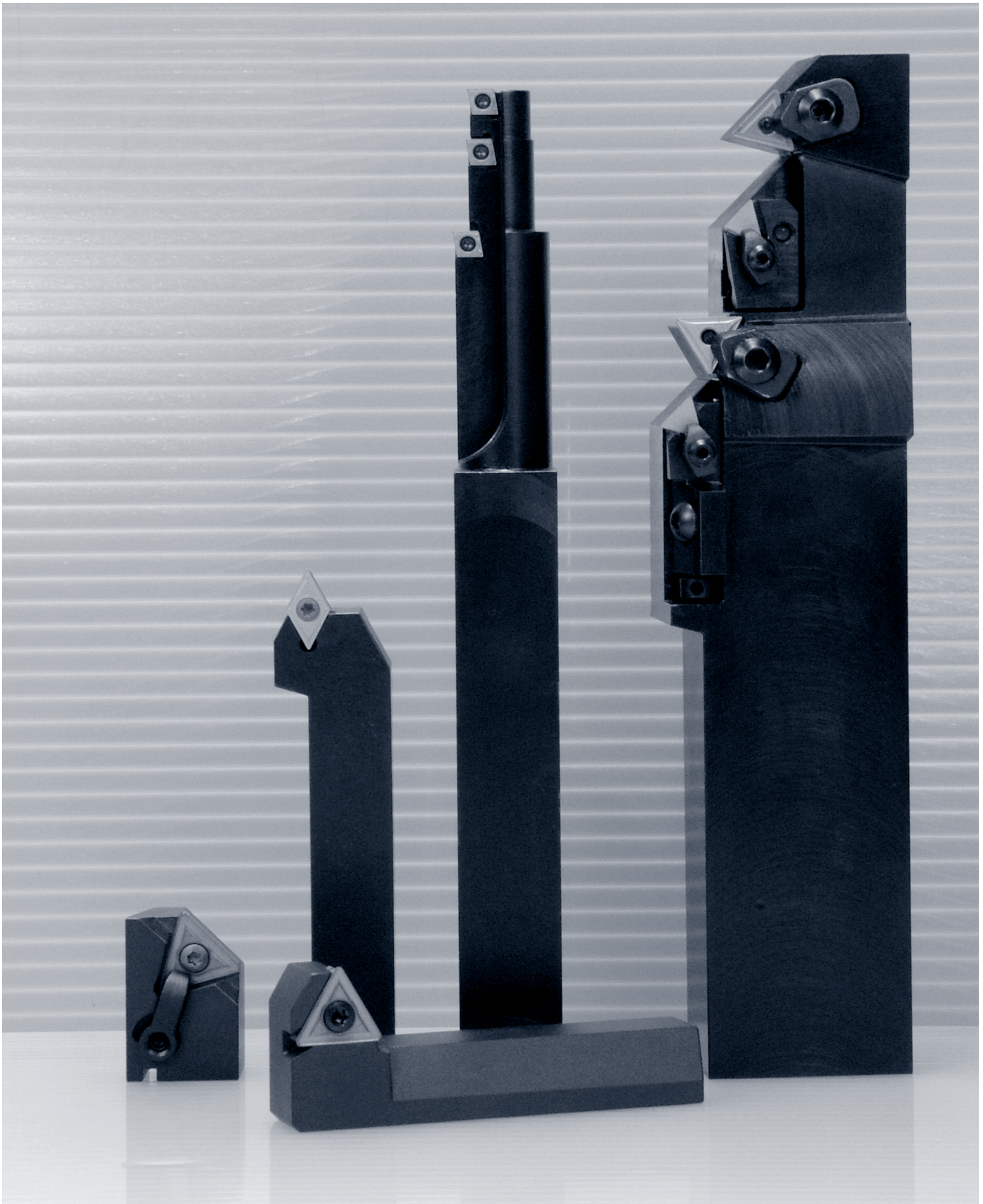

Special tools are required to achieve different applications, either to reduce machining time or because there is no standard tool which can accomplish a specific machining operation. Eines CANELA gives to his costumers the possibility of manufacturing this tooling, starting from a drawing or making a study about the piece that has to be machined. The wide range of possibilities offered by the manufacture of special tooling helps to solve all machining problems from the small machining companies to the aerospace industry.





General turning

Aluminium wheel turning

Automatic lathes

Ceramic tools

Parting and grooving

Threading

Drills

Cartridges

Brazed tools

Tooling